



Isolation Galvanic isolators for analogue and digital signals as well as HART® signals. A wide product range with both loop-powered and universal isolators featuring linearisation, inversion, and scaling of output signals.



Displays Programmable displays with a wide selection of inputs and outputs for display of temperature, volume, weight, etc. Feature linearisation, scaling, and difference measurement functions for programming via PReset software.



Ex barriers Interfaces for analogue and digital signals as well as HART® signals between sensors / I/P converters / frequency signals and control systems in Ex zone 0, 1 & 2. Feature options such as mathematical functions and 2 wire transmitter interfaces.



Temperature A wide selection of transmitters for DIN form B mounting and DIN rail modules with analogue and digital bus communication ranging from application-specific to universal transmitters.



Backplane Flexible motherboard solutions for system 5000 modules. Our backplane range features flexible 8 and 16 module solutions with configuration via PReplan 8470 – a PC program with drop-down menus.



- DK Side 1
- UK Page 15
- FR Page 29
- DE Seite 43

5 3 3 5

**2-Wire Transmitter
with HART® Protocol**

No. 5335V108-IN (0546)
From ser. no. 040909001



SIGNALS THE BEST

2-TRÅDS TRANSMITTER MED HART[®] PROTOKOL

PRetop 5335

Indholdsfortegnelse

Sikkerhedsinstruktion	2
Overensstemmelseserklæring	3
Anvendelse	4
Teknisk karakteristik	4
Montage / installation.....	4
Applikationer	5
Bestillingsskema.....	6
Elektriske specifikationer	6
Tilslutninger	10
Blokdiagram	11
Programmering.....	12
Forbindelse af transmittere i multidrop	14
Mekaniske specifikationer.....	14
Montering af følerledninger	14
Appendix:	
FM Installation Drawing No. 5300Q502	58
CSA Installation Drawing No. 533XQC03	60

Sikkerhedsinstruktion

Ex-installation:

For sikker installation af 5335B, C og D i eksplosionsfarligt område skal følgende overholdes. Installation må kun foretages af kvalificeret personale, der er bekendt med de nationale og internationale love, direktiver og standarder, der gælder for området.

Produktionsår fremgår af de to første cifre i serienummeret.

For installationsanvisninger og Ex-data henvises til ATEX-certifikater.

OVERENSSTEMMELSESERKLÆRING

Som producent erklærer

PR electronics A/S

Lerbakken 10

DK-8410 Rønde

hermed at følgende produkt:

Type: 5335

Navn: 2-Tråds transmitter med HART® protokol

er i overensstemmelse med følgende direktiver og standarder:

EMC-direktivet 2004/108/EF og senere tilføjelser

EN 61326

Denne erklæring er udgivet i overensstemmelse med EMC-direktivets paragraf 10, stk. 1. For specifikation af det acceptable EMC-niveau henvises til modules elektriske specifikationer.

ATEX-direktivet 94/9/EF og senere tilføjelser

EN 50021, EN 50014, EN 50020,

EN 50281-1-1 og EN 50284

ATEX-certifikat: KEMA 03ATEX1508 X (5335A)

ATEX-certifikat: KEMA 03ATEX1537 X (5335B, C og D)

Bemyndiget organ for CENELEC / ATEX: **UL International Demko A/S 0539**



Rønde, 17. nov. 2005

Peter Rasmussen
Producentens underskrift

2-TRÅDS TRANSMITTER MED HART[®] PROTOKOL

Pretop 5335

- Indgang for RTD, TC, Ohm eller mV
- Ekstrem målenøjagtighed
- HART[®]-kommunikation
- Galvanisk isolation
- Kan monteres i DIN form B følerhoved

Anvendelse:

- Temperaturlineariseret måling med Pt100...Pt1000, Ni100...Ni1000 eller termoelementføler.
- Differens- eller gennemsnitstemperaturmåling på 2 modstands- eller TC-følere.
- Omsætning af lineær modstandsændring til standard analogt strømsignal, f.eks. fra ventiler eller ohmske niveaustave.
- Forstærkning af bipolært mV-signal til et standard 4...20 mA strømsignal.
- Kobling af op til 15 transmittere til et digitalt 2-leder signal med HART[®]-kommunikation.

Teknisk karakteristik:

- PR5335 kan af brugeren i løbet af få sekunder programmeres til at måle inden for alle normerede temperaturområder.
- RTD- og modstandsindgangen har kabelkompensering for 2-, 3- og 4-leder tilslutning.
- Der er løbende sikkerhedscheck af gemte data.
- Følerejlsdetektering iht. retningslinierne i NAMUR NE 89.

Montage / installation:

- Kan monteres i DIN form B følerhoved. I ikke-eksplosionsfarlige områder kan 5335 monteres på en DIN-skinne med et specielt beslag.
- **NB:** Som Ex-barriere for 5335B, C og D anbefaler vi 5106B.

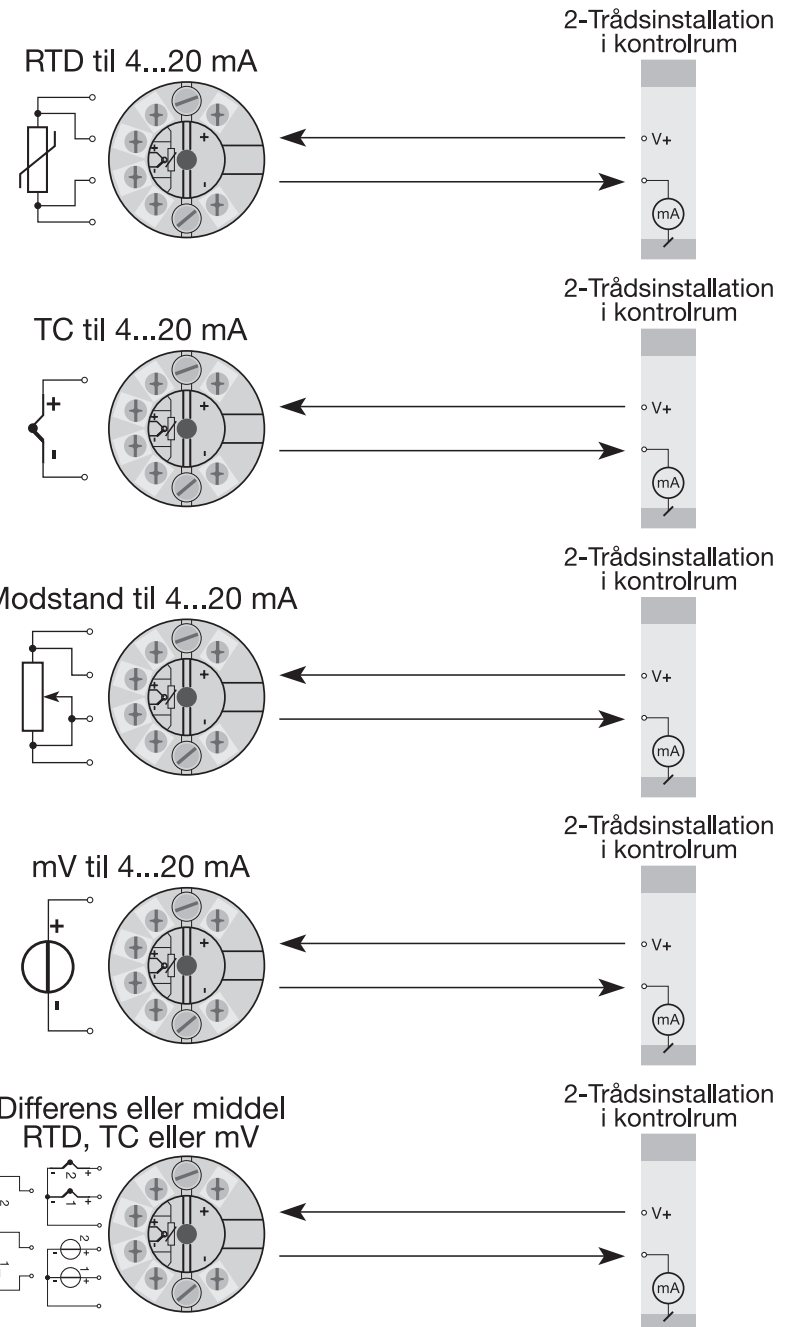

Bestillingsskema: 5335

Type	Version
5335	Standard : A
	ATEX : B
	FM og ATEX : C
	CSA, FM og ATEX : D

Elektriske specifikationer:

Specifikationsområde:

-40°C til +85°C

Fælles specifikationer:

Forsyningsspænding, DC

Standard, 5335A	8,0...35 V
ATEX, 5335B	8,0...30 V
FM og CSA, 5335C og D	8,0...28 V
Isolationsspænding, test / drift	1,5 kVAC / 50 VAC
Opvarmningstid	30 s
Kommunikationsinterface	HART® og Loop Link
Signal- / støjforhold	Min. 60 dB
Reaktionstid (programmerbar)	1...60 s
EEPROM fejlcheck	< 10 s
Signaldynamik, indgang	22 bit
Signaldynamik, udgang	16 bit
Kalibreringstemperatur	20...28°C

Nøjagtighed, størst af generelle og basisværdier:

Generelle værdier		
Indgangstype	Absolut nøjagtighed	Temperaturkoefficient
Alle	$\leq \pm 0,05\%$ af span	$\leq \pm 0,005\%$ af span / °C

Basisværdier		
Indgangstype	Basisnøjagtighed	Temperaturkoefficient
Pt100 og Pt1000	$\leq \pm 0,1^\circ\text{C}$	$\leq \pm 0,005^\circ\text{C}/^\circ\text{C}$
Ni100	$\leq \pm 0,2^\circ\text{C}$	$\leq \pm 0,005^\circ\text{C}/^\circ\text{C}$
Lin. R	$\leq \pm 0,1 \Omega$	$\leq \pm 5 \text{ m}\Omega/^\circ\text{C}$
Volt	$\leq \pm 10 \mu\text{V}$	$\leq \pm 0,5 \mu\text{V}/^\circ\text{C}$
TC-type: E, J, K, L, N, T, U	$\leq \pm 0,5^\circ\text{C}$	$\leq \pm 0,025^\circ\text{C}/^\circ\text{C}$
TC-type: B, R, S, W3, W5	$\leq \pm 1^\circ\text{C}$	$\leq \pm 0,1^\circ\text{C}/^\circ\text{C}$

EMC-immunitetspårvirkning	< $\pm 0,1\%$ af span
Udvidet EMC-immunitet: NAMUR NE 21, A kriterium, gniststøj	< $\pm 1\%$ af span

Virkning af forsyningsspændings-

ændring	< 0,005% af span / VDC
Vibration	IEC 60068-2-6 Test FC
Lloyd's specifikation nr. 1	4 g / 2...100 Hz
Max. ledningskvadrat	1 x 1,5 mm ² flerkoret ledning
Luftfugtighed	< 95% RH (ikke kond.)
Mål	Ø 44 x 20,2 mm
Tæthedegrad (hus / klemme)	IP68 / IP00
Vægt	50 g

Elektriske specifikationer indgang:

Max. nulpunktsforskydning (offset) 50% af valgt numerisk max. værdi

RTD- og lineær modstandsindgang:

RTD-type	Min. værdi	Max. værdi	Min. span
Pt100	-200°C	+850°C	10°C
Ni100	-60°C	+250°C	10°C
Lin. R	0 Ω	7000 Ω	25 Ω

Kabelmodstand pr. leder (max.)	5 Ω
Følerstrøm	Nom. 0,2 mA
Virkning af følerkabelmodstand (3- / 4-leder)	< 0,002 Ω/Ω

Følerfejlsdetektering Ja
 Kortslutningsdetektering Hvis 0% > 30 Ω

TC-indgang:

Type	Min. temperatur	Max. temperatur	Min. span	Norm
B	+400°C	+1820°C	100°C	IEC584
E	-100°C	+1000°C	50°C	IEC584
J	-100°C	+1200°C	50°C	IEC584
K	-180°C	+1372°C	50°C	IEC584
L	-100°C	+900°C	50°C	DIN 43710
N	-180°C	+1300°C	50°C	IEC584
R	-50°C	+1760°C	100°C	IEC584
S	-50°C	+1760°C	100°C	IEC584
T	-200°C	+400°C	50°C	IEC584
U	-200°C	+600°C	50°C	DIN 43710
W3	0°C	+2300°C	100°C	ASTM E988-90
W5	0°C	+2300°C	100°C	ASTM E988-90

Koldt loddestedskomp. (CJC)..... < ±1,0 °C
 Ekstern CJC med Ni100 eller Pt100 -40 ≤ T_{omg.} ≤ 135°C
 Følerfejlsdetektering Ja

Følerfejlsstrøm:

under detektering..... Nom. 33 µA
 ellers..... 0 µA

Kortslutningsdetektering Hvis 0% > 5 mV

Spændingsindgang:

Måleområde -800...+800 mV
 Min. måleområde (span)..... 2,5 mV
 Indgangsmodstand 10 MΩ

Strømodgang:

Signalområde 4...20 mA
 Min. signalområde..... 16 mA
 Opdateringstid..... 440 ms
 (660 ms for diff.)
 Fast udgangssignal Mellem 4 og 20 mA
 Udgangssignal ved EEpromfejl ≤ 3,5 mA
 Belastningsmodstand..... ≤ (V_{forsyn.} - 8) / 0,023 [Ω]
 Belastningsstabilitet < ±0,01% af span / 100 Ω

Følerfejlsdetektering:

Programmerbar 3,5...23 mA
 NAMUR NE43 Upscale 23 mA
 NAMUR NE43 Downscale..... 3,5 mA

Ex- / I.S.-data:

Signaludgang / forsyning, terminal 1 til 2:
 U_i..... : 30 VDC
 I_i..... : 120 mADC
 P_i..... : 0,84 W
 L_i..... : 10 µH
 C_i..... : 1,0 nF

Følerindgang, terminal 3, 4, 5 og 6:

U_o..... : 9,6 VDC
 I_o..... : 28 mA
 P_o..... : 67 mW
 L_o..... : 35 mH
 C_o..... : 3,5 µF

EEx- / I.S.-godkendelse 5335A:

KEMA 03ATEX1508 X.....  II 3 GD
 EEx nA[L] IIC T4 eller T6

EEx- / I.S.-godkendelse 5335B, C og D:

KEMA 03ATEX1537 X.....  II 1 GD, T80°C...T105°C
 EEx ia IIC T6 / T4
 Max. omgivelsestemp. for T1...T4 85°C
 Max. omgivelsestemp. for T5 og T6 60°C
 ATEX, må anvendes i zone..... 0, 1, 2, 20, 21 eller 22
 FM, må anvendes i..... IS, Class I, DIV. 1, Group A, B, C, D
 IS, Class I, Zone 0, AEx ia IIC
 Entity, FM Installation Drawing No. 5300Q502
 CSA, må anvendes i..... IS, Class I, DIV. 1, Group A, B, C, D,
 Ex ia IIC
 IS, Class I, Zone 0, AEx ia IIC
 Installation Drawing No. 533XQC03

Marine-godkendelse:

Det Norske Veritas, Ships & Offshore Standard for Certification No. 2.4

Overholdte myndighedskrav:

Standard:
 EMC 2004/108/EF
 Emission og immunitet..... EN 61326
 ATEX 94/9/EF EN 50021, EN 50014, EN 50020
 EN 50284 og EN 50281-1-1
 FM, ASCN 3600, 3611, 3610
 CSA, CAN / CSA..... C22.2 No. 157, E60079-11, UL 913

Af span = Af det aktuelt valgte område

Tilslutninger:

Indgang:

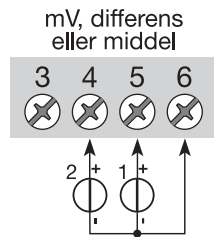
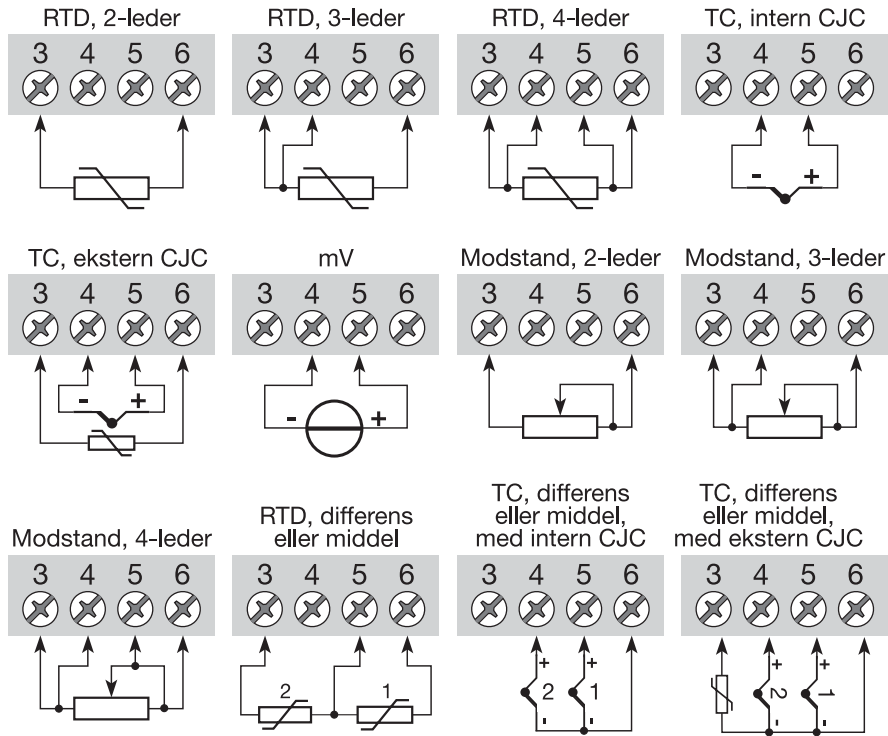

Udgang:

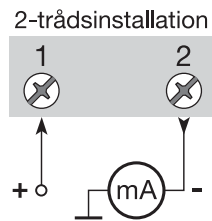

BLOKDIAGRAM:

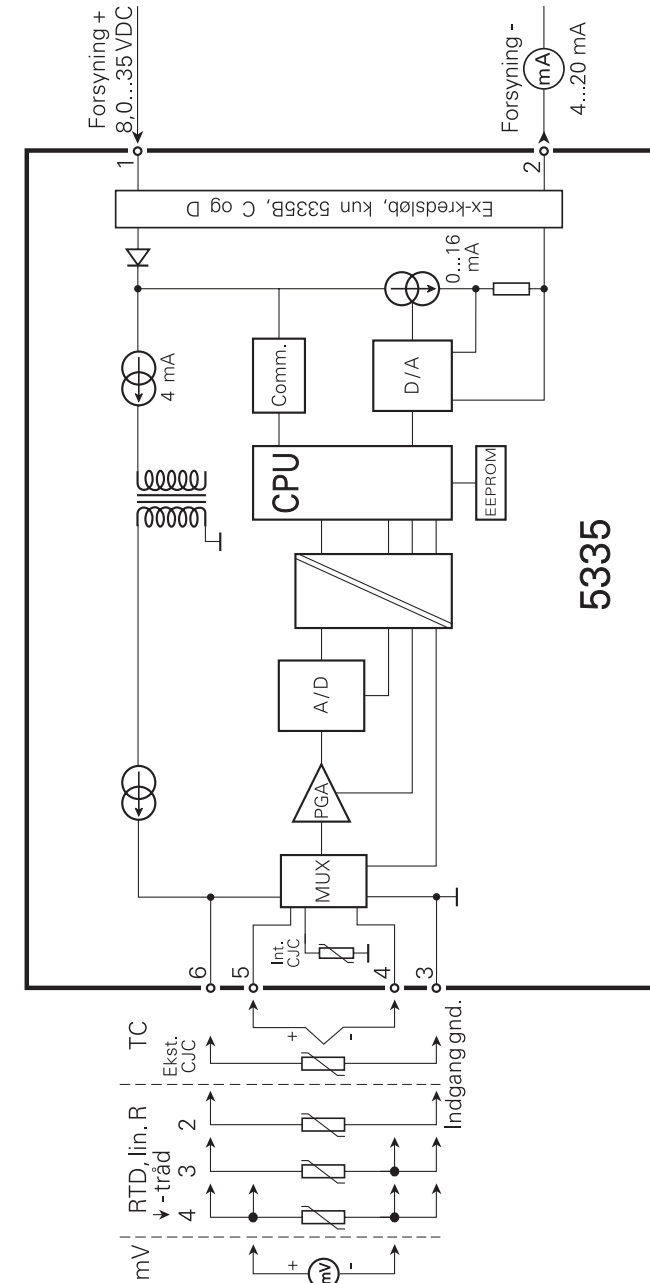

Programmering:

PRetop 5335 kan konfigureres på 3 måder:

- 1 Med PR electronics A/S' kommunikationsinterface Loop Link og PReset PC konfigurationssoftware.
2. Med HART® modem og PReset PC konfigurationssoftware.
3. Med HART® kommunikator indeholdende PR electronics A/S' DDL driver.

1: Loop Link:

Ved programmering henvises til tegningen nedenfor og hjælpefunktionen i PReset programmet.

Loop Link må ikke benyttes til kommunikation med moduler installeret i Ex-område.

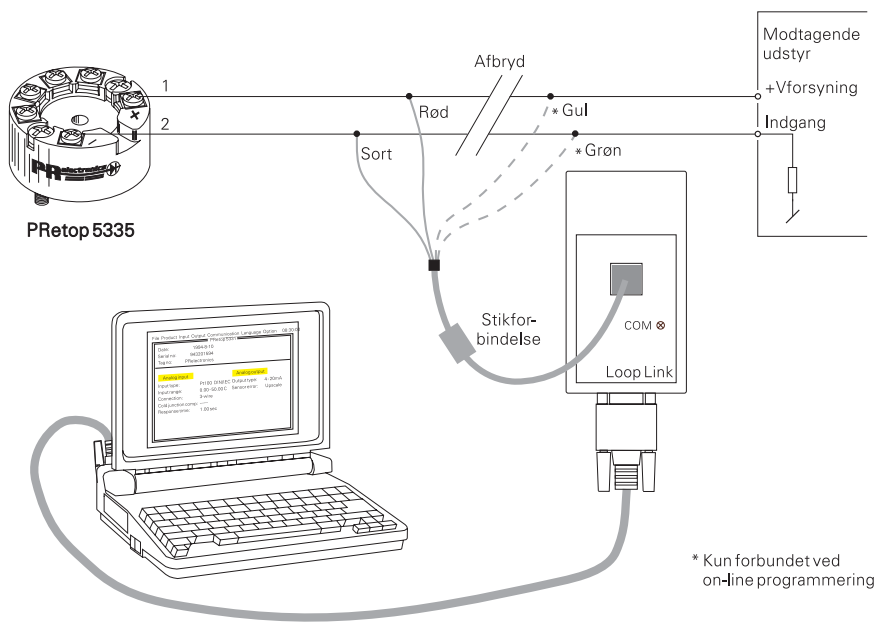

2: HART® modem:

Ved programmering henvises til tegningen nedenfor og hjælpefunktionen i PReset programmet.

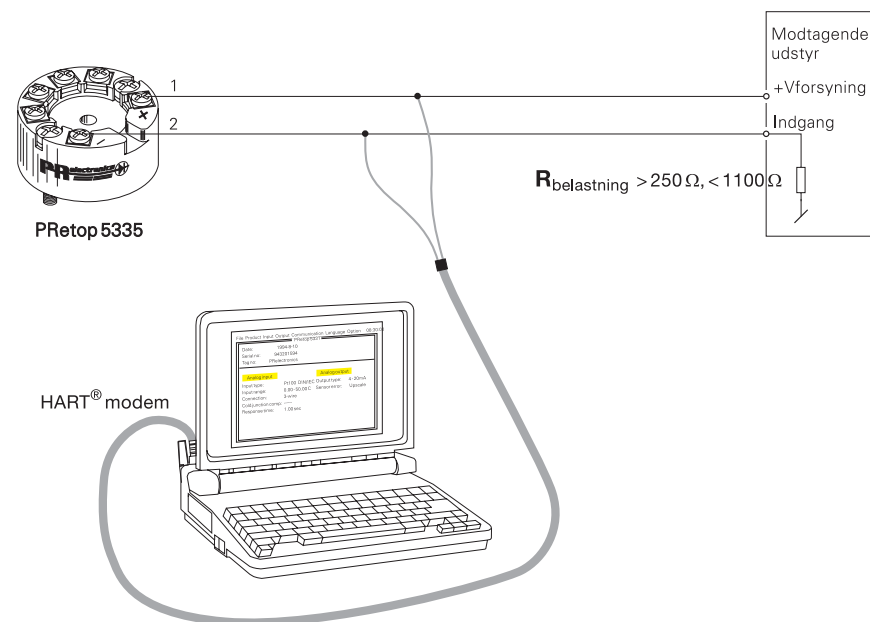

3: HART® kommunikator:

Ved programmering henvises til tegningen nedenfor. For at få adgang til produktspecifikke kommandoer skal HART® kommunikatoren indeholde PR electronics A/S' DDL driver. Denne kan rekvireres enten hos HART® Communication Foundation eller hos PR electronics A/S.

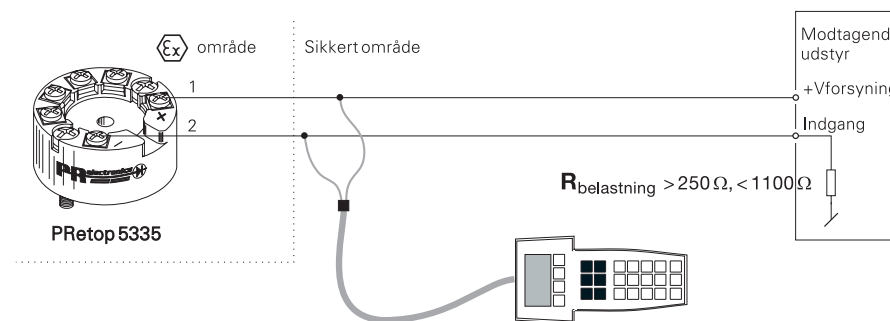

Forbindelse af transmittere i multidrop:

HART® kommunikatoren eller PC-modem kan tilsluttes over punkterne AB eller BC.

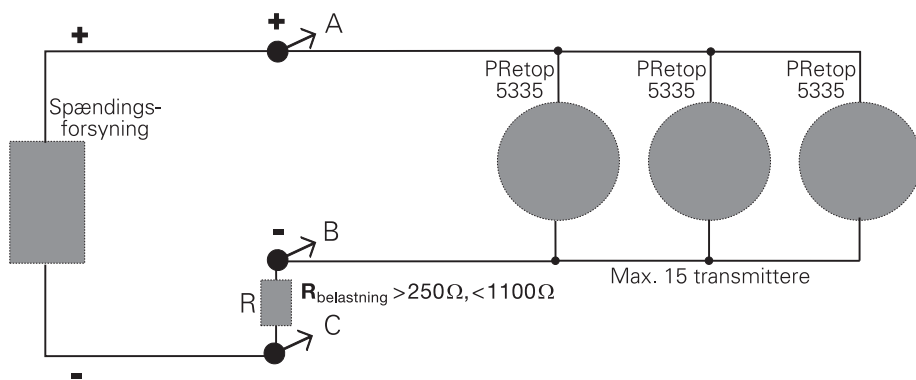

Udgangene på op til 15 transmittere kan parallelforbindes for digital HART®-kommunikation på 2-ledere.

Hver transmitter skal, inden den tilsluttes, konfigureres med et unikt nummer fra 1 - 15. Hvis 2 transmittere konfigureres med samme nummer, ses der bort fra begge. Transmitterne skal programmeres til multidrop mode (med et fast udgangssignal på 4 mA). Den maksimale strøm i sløjfen kan dermed blive 60 mA. Kommunikationen kan foregå via HART® kommunikator eller HART® modem.

PRreset PC konfigurationssoftwaren kan konfigurere den enkelte transmitter til multidrop mode og tildele en unik polling adresse.

Mekaniske specifikationer:

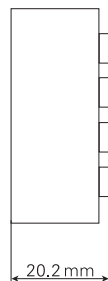
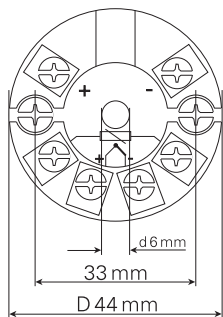

Montering af følerledninger:

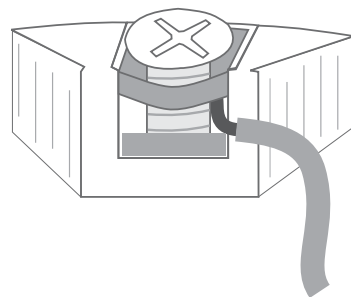

Ledninger monteres mellem metalpladerne

2-WIRE TRANSMITTER WITH HART® PROTOCOL

PRetop 5335

CONTENTS

Safety instructions.....	16
Declaration of Conformity	17
Application	18
Technical characteristics	18
Mounting / installation.....	18
Applications.....	19
Order	20
Electrical specifications.....	20
Connections	24
Block diagram	25
Programming.....	26
Connection of transmitters in multidrop mode.....	28
Mechanical specifications.....	28
Mounting of sensor wires.....	28
Appendix:	
FM Installation Drawing No. 5300Q502.....	58
CSA Installation Drawing No. 533XQC03	60

Safety instructions

Ex / I.S. installation:

For a safe installation of 5335B, C and D in hazardous area the following must be observed. The module must only be installed by qualified personnel who are familiar with the national and international laws, directives and standards that apply to this area.

Year of manufacture can be taken from the first two digits in the serial number.

For installation requirements and Ex / I.S. data see ATEX certificates.

DECLARATION OF CONFORMITY

As manufacturer

PR electronics A/S

Lerbakken 10

DK-8410 Rønde

hererby declares that the following product:

Type: 5335

Name: 2-Wire transmitter with HART® protocol

is in conformity with the following directives and standards:

EMC directive 2004/108/EC and later amendments

EN 61326

This declaration is issued in compliance with article 10, subclause 1 of the EMC directive. For specification of the acceptable EMC performance level, refer to the electrical specifications for the module.

The ATEX directive 94/9/EC and later amendments

EN 50014, EN 50020, EN 50021,

EN 50281-1-1 and EN 50284

ATEX certificate: KEMA 03ATEX1508 X (5335A)

ATEX certificate: KEMA 03ATEX1537 X (5335B, C and D)

Notified body for CENELEC/ATEX: UL International Demko A/S 0539

Rønde, 17 Nov. 2005



Peter Rasmussen
Manufacturer's signature

2-WIRE TRANSMITTER WITH HART® PROTOCOL PRetop 5335

- *RTD, TC, Ohm, or mV input*
- *Extremely high measurement accuracy*
- *HART® communication*
- *Galvanic isolation*
- *For DIN form B sensor head mounting*

Application:

- Linearised temperature measurement with Pt100...Pt1000, Ni100...Ni1000, or TC sensor.
- Difference or average temperature measurement of 2 resistance or TC sensors.
- Conversion of linear resistance variation to a standard analogue current signal, for instance from valves or Ohmic level sensors.
- Amplification of a bipolar mV signal to a standard 4...20 mA current signal.
- Connection of up to 15 transmitters to a digital 2-wire signal with HART® communication.

Technical characteristics:

- Within a few seconds the user can program PR5335 to measure temperatures within all ranges defined by the norms.
- The RTD and resistance inputs have cable compensation for 2-, 3- and 4-wire connection.
- Continuous check of vital stored data for safety reasons.
- Sensor error detection according to the guidelines in NAMUR NE 89.

Mounting / installation:

- For DIN form B sensor head mounting. In non-hazardous areas the 5335 can be mounted on a DIN rail with a special fitting.
- **NB:** As Ex barrier for 5335B, C and D we recommend 5106B.

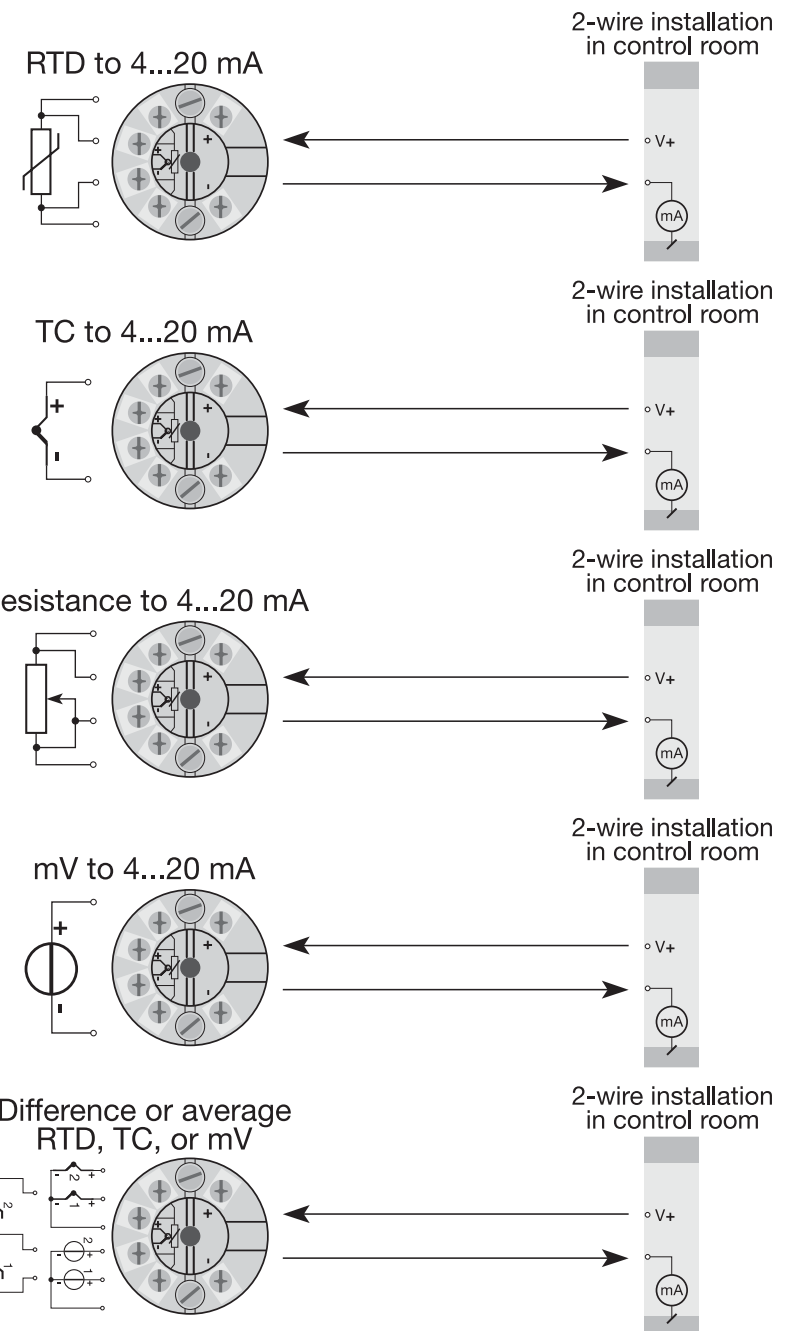

Order: 5335

Type	Version
5335	Standard : A
	ATEX : B
	FM and ATEX : C
	CSA, FM and ATEX : D

Electrical specifications:

Specifications range:

-40°C to +85°C

Common specifications:

Supply voltage, DC

Standard, 5335A 8.0...35 V

ATEX, 5335B 8.0...30 V

FM and CSA, 5335C and D 8.0...28 V

Isolation voltage, test / operation 1.5 kVAC / 50 VAC

Warm-up time 30 s

Communications interface HART® and Loop Link

Signal / noise ratio Min. 60 dB

Response time (programmable) 1...60 s

EEPROM error check < 10 s

Signal dynamics, input 22 bit

Signal dynamics, output 16 bit

Calibration temperature 20...28°C

Accuracy, the greater of general and basic values:

General values		
Input type	Absolute accuracy	Temperature coefficient
All	≤ ±0.05% of span	≤ ±0.005% of span / °C

Basic values		
Input type	Basic accuracy	Temperature coefficient
Pt100 and Pt1000	≤ ±0.1°C	≤ ±0.005°C/°C
Ni100	≤ ±0.2°C	≤ ±0.005°C/°C
Lin. R	≤ ±0.1 Ω	≤ ±5 mΩ/°C
Volt	≤ ±10 μV	≤ ±0.5 μV/°C
TC type: E, J, K, L, N, T, U	≤ ±0.5°C	≤ ±0.025°C/°C
TC type: B, R, S, W3, W5	≤ ±1°C	≤ ±0.1°C/°C

EMC immunity influence	< ±0.1% of span
Extended EMC immunity: NAMUR NE 21, A criterion, burst	< ±1% of span

Effect of supply voltage variation < 0.005% of span / VDC

Vibration IEC 60068-2-6 Test FC

Lloyd's specification no. 1 4 g / 2...100 Hz

Max. wire size 1 x 1.5 mm² stranded wire

Relative humidity < 95% RH (non-cond.)

Dimensions Ø 44 x 20.2 mm

Tightness (enclosure / terminals) IP68 / IP00

Weight 50 g

Electrical specifications, input:

Max. offset 50% of selec. numerical max. value

RTD and linear resistance input:

RTD type	Min. value	Max. value	Min. span
Pt100	-200°C	+850°C	10°C
Ni100	-60°C	+250°C	10°C
Lin. R	0 Ω	7000 Ω	25 Ω

Cable resistance per wire (max.) 5 Ω

Sensor current Nom. 0.2 mA

Effect of sensor cable resistance

(3- / 4-wire) < 0.002 Ω/Ω

Sensor error detection Yes
 Short circuit detection If 0% > 30 Ω

TC input:

Type	Min. temperature	Max. temperature	Min. span	Norm
B	+400°C	+1820°C	100°C	IEC584
E	-100°C	+1000°C	50°C	IEC584
J	-100°C	+1200°C	50°C	IEC584
K	-180°C	+1372°C	50°C	IEC584
L	-100°C	+900°C	50°C	DIN 43710
N	-180°C	+1300°C	50°C	IEC584
R	-50°C	+1760°C	100°C	IEC584
S	-50°C	+1760°C	100°C	IEC584
T	-200°C	+400°C	50°C	IEC584
U	-200°C	+600°C	50°C	DIN 43710
W3	0°C	+2300°C	100°C	ASTM E988-90
W5	0°C	+2300°C	100°C	ASTM E988-90

Cold junction compensation < ±1.0°C
 External CJC with Ni100 or Pt100 -40 ≤ T_{amb.} ≤ 135°C
 Sensor error detection Yes
 Sensor error current:
 When detecting Nom. 33 µA
 Else 0 µA
 Short circuit detection If 0% > 5 mV

Voltage input:

Measurement range -800...+800 mV
 Min. span 2.5 mV
 Input resistance 10 MΩ

Current output:

Signal range 4...20 mA
 Min. signal range 16 mA
 Updating time 440 ms
 (660 ms for diff.)
 Fixed output signal Between 4 and 20 mA
 Output signal at EEPROM error ≤ 3.5 mA
 Load resistance ≤ (V_{supply} - 8) / 0.023 [Ω]
 Load stability < ±0.01% of span / 100 Ω

Sensor error detection:

Programmable 3.5...23 mA
 NAMUR NE43 Upscale 23 mA
 NAMUR NE43 Downscale 3.5 mA

Ex / I.S. data:

Signal output / supply, terminal 1 to 2:
 U_i : 30 VDC
 I_i : 120 mADC
 P_i : 0.84 W
 L_i : 10 µH
 C_i : 1.0 nF

Sensor input, terminal 3, 4, 5 and 6:

U_o : 9.6 VDC
 I_o : 28 mA
 P_o : 67 mW
 L_o : 35 mH
 C_o : 3.5 µF

Ex / I.S. approval 5335A:

Kema 03ATEX1508 X  II 3 GD
 EEx nA[L] IIC T4...T6

Ex / I.S. approval 5335B, C and D:

KEMA 03ATEX1537 X  II 1 GD, T80°C...T105°C
 EEx ia IIC T6 / T4
 Max. amb. temperature for T1...T4 85°C
 Max. amb. temperature for T5 and T6 60°C
ATEX, applicable in zone 0, 1, 2, 20, 21 or 22
FM, applicable in IS, Class I, DIV. 1, Group A, B, C, D
 IS, Class I, Zone 0, AEx ia IIC
 Entity, FM Installation Drawing No. 5300Q502
CSA, applicable in IS, Class I, DIV. 1, Group A, B, C, D,
 Ex ia IIC
 IS, Class I, Zone 0, AEx ia IIC
 Installation Drawing No. 533XQC03

Marine approval:

Det Norske Veritas, Ships & Offshore Standard for Certification No. 2.4

Observed authority requirements:

Standard:
 EMC 2004/108/EC
 Emission and immunity EN 61326
 ATEX 94/9/EC EN 50014, EN 50020, 50284
 EN 50021 and EN 50281-1-1
 FM, ASCN 3600, 3611, 3610
 CSA, CAN / CSA C22.2 No. 157, E60079-11, UL 913

Of span = Of the presently selected range

Connections:

Input:

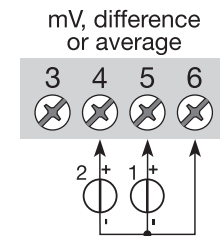
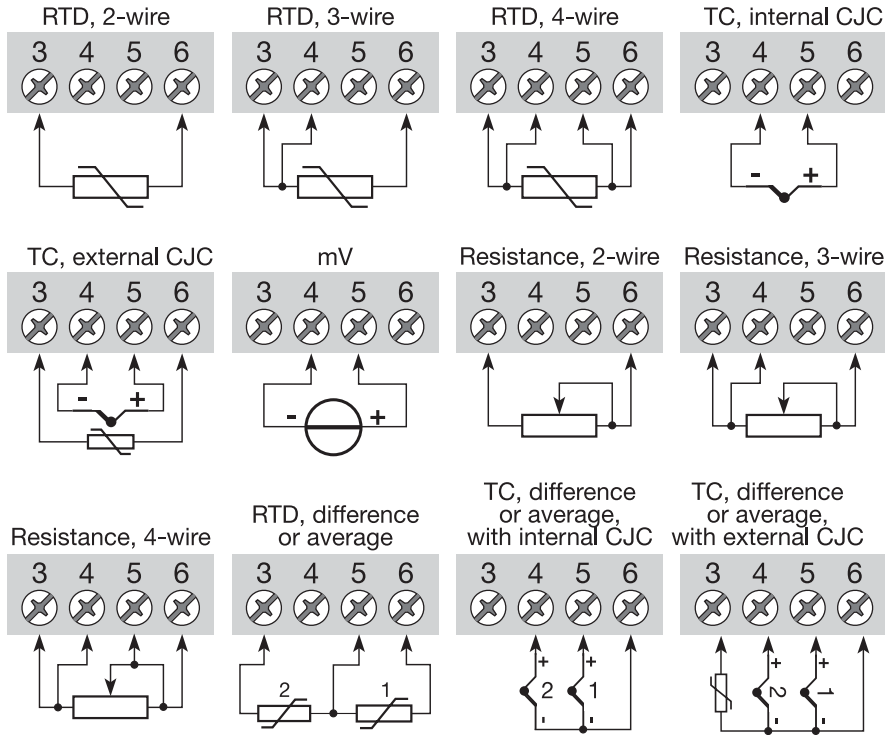

Output:

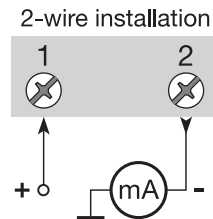

BLOCK DIAGRAM:

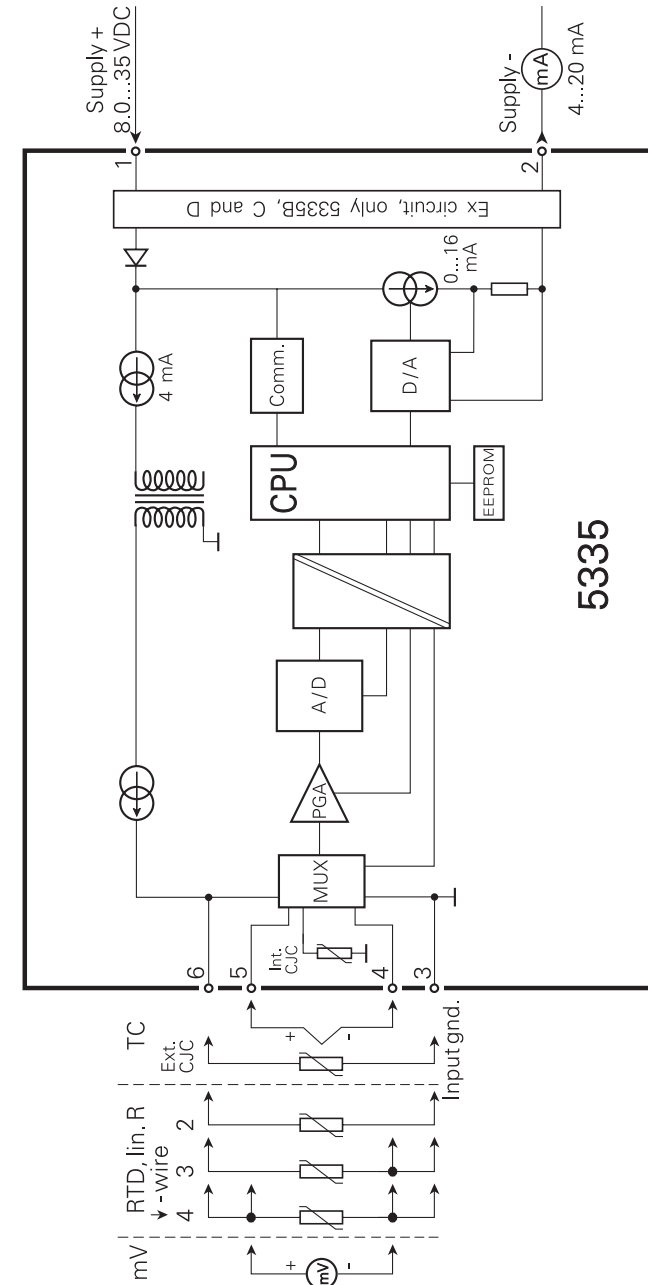

Programming:

PRetop 5335 can be configured in the following 3 ways:

- 1 With PR electronics A/S' communications interface Loop Link and PReset PC configuration software.
2. With a HART® modem and PReset PC configuration software.
3. With a HART® communicator with PR electronics A/S' DDL driver.

1: Loop Link:

For programming please refer to the drawing below and the help functions in PReset.

Loop Link is not approved for communication with modules installed in hazardous (Ex) areas.

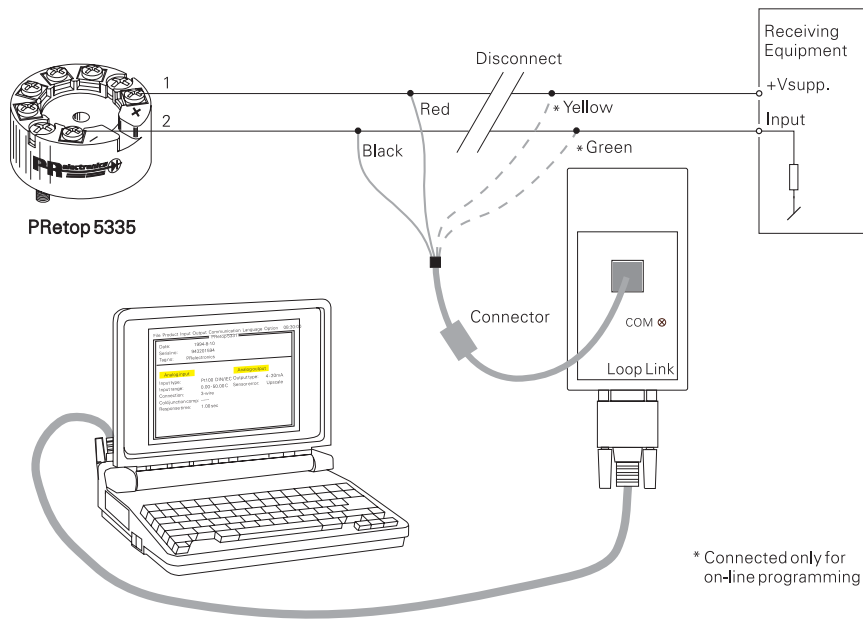

2: HART® modem:

For programming please refer to the drawing below and the help functions in PReset.

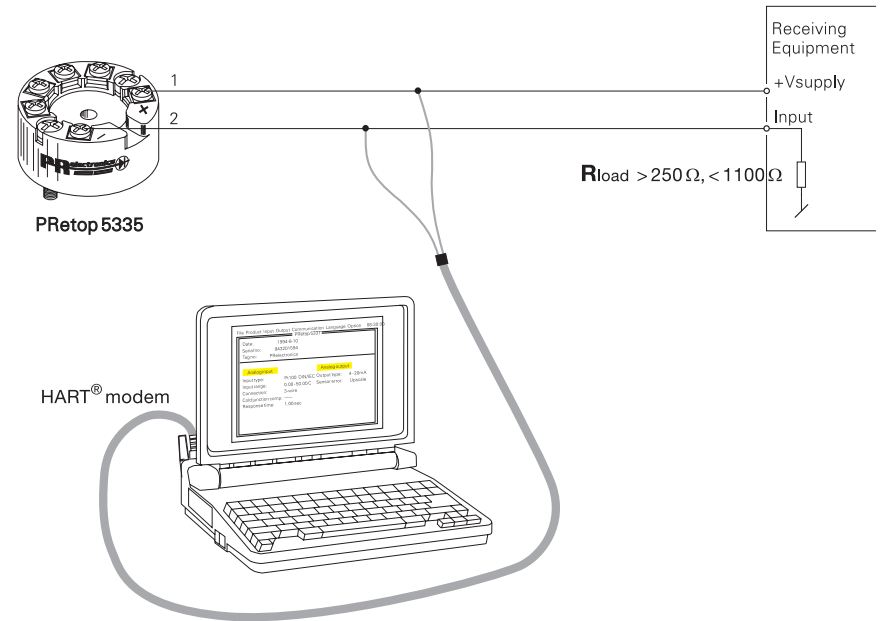

3: HART® communicator:

For programming please refer to the drawing below. To gain access to product-specific commands, the HART® communicator must be loaded with the PR electronics A/S DDL driver. This can be ordered either at the HART® Communication Foundation or at PR electronics A/S.

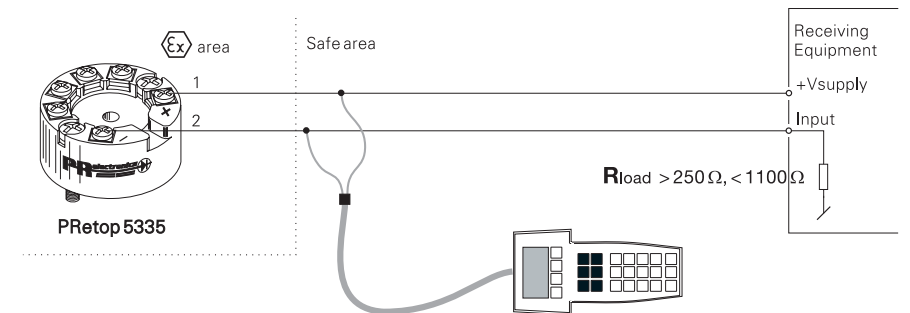

Connection of transmitters in multidrop mode:

The HART® communicator or a PC modem can be connected across AB or BC.

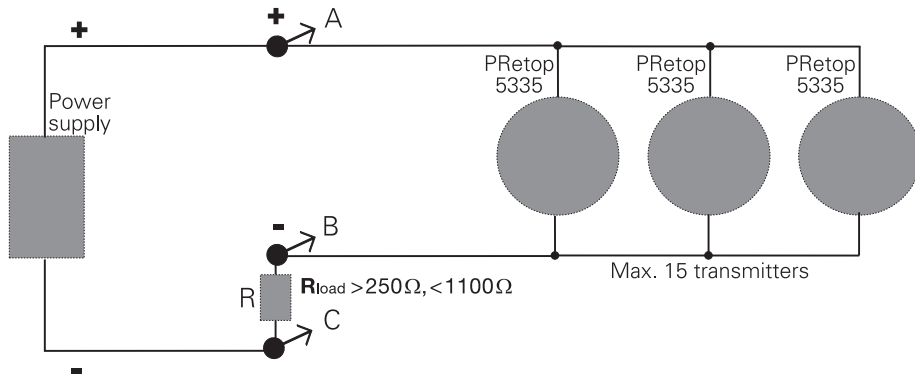

The outputs of max. 15 transmitters can be connected in parallel for a digital HART® communication on 2-wires.

Before it is connected, each transmitter must be configured with a unique number from 1 to 15. If 2 transmitters are configured with the same number, both will be excluded. The transmitters must be programmed for multidrop mode (with a fixed output signal of 4 mA). Maximum current in the loop is therefore 60 mA. The communication is either by means of a HART® communicator or a HART® modem.

The PRreset PC configuration software can configure the individual transmitter for multidrop mode and provide it with a unique polling address.

Mechanical specifications:

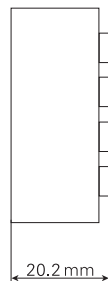
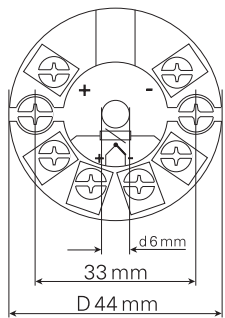

Mounting of sensor wires

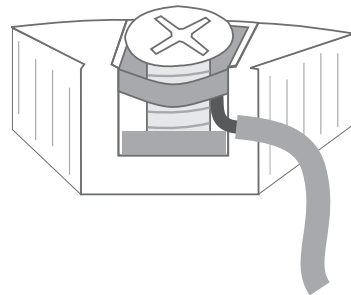

Wires must be mounted between the metal plates.

TRANSMETTEUR 2-FILS AVEC PROTOCOLE HART®

PRetop 5335

SOMMAIRE

Consignes de sécurité	30
Declaration de conformité.....	31
Application	32
Caractéristiques techniques	32
Montage / installation.....	32
Applications.....	33
Référence	34
Spécifications électriques	34
Connexions	38
Schéma de principe	39
Programmation.....	40
Raccordement des transmetteurs en multi-adressage.....	42
Dimensions mécaniques	42
Montage des fils du capteur	42
Appendix:	
FM Installation Drawing No. 5300Q502.....	58
CSA Installation Drawing No. 533XQC03	60

Consignes de sécurité

Installation S.I. :

Pour l'installation de 5335B, C et D dans les zones dangereuses, conformez-vous aux consignes de sécurité suivantes : l'installation ne doit être réalisée que par du personnel qualifié connaissant la législation nationale et internationale ainsi que les directives et standards régissant ce domaine.

L'année de production ressort des deux premiers chiffres du numéro de série.

Pour les conditions d'installation et les données de sécurité intrinsèque, voir les certificats ATEX.

DECLARATION DE CONFORMITE

En tant que fabricant

PR electronics A/S

Lerbakken 10

DK-8410 Rønde

déclare que le produit suivant :

Type : 5335

Nom : Transmetteur 2-fils avec protocole HART®

correspond aux directives et normes suivantes :

La directive CEM (EMC) 2004/108/CE et les modifications subséquentes

EN 61326

Cette déclaration est délivrée en correspondance à l'article 10, alinéa 1 de la directive CEM. Pour une spécification du niveau de rendement acceptable CEM (EMC) se référer aux spécifications électriques du module.

La directive ATEX 94/9/CE et les modifications subséquentes

EN 50014, EN 50020, EN 50021,

EN 50281-1-1 et EN 50284

Certificat ATEX: KEMA 03ATEX1508 X (5335A)

Certificat ATEX: KEMA 03ATEX1537 X (5335B, C et D)

Organisme notifié pour CENELEC/ATEX: **UL International Demko A/S 0539**

Rønde, le 17 novembre 2005



Peter Rasmussen
Signature du fabricant

TRANSMETTEUR 2-FILS AVEC PROTOCOLE HART® PRetop 5335

- *Entrée RTD, TC, Ohm ou mV*
- *Très grande précision de mesure*
- *Communication avec protocole HART®*
- *Isolation galvanique*
- *Pour tête de sonde DIN B*

Application :

- Mesure linéarisée de la température avec un capteur Pt100...Pt1000, Ni100...Ni1000 ou de thermocouples.
- Mesure de la température différentielle ou moyenne avec 2 sondes résistives ou thermocouples.
- Conversion d'une résistance linéaire en un signal courant standard analogique pour mesurer par exemple le niveau ou la position d'une vanne.
- Amplification d'un signal mV bipolaire en un signal courant standard de 4...20 mA.
- Connexion en parallèle de 15 transmetteurs au maximum pour une communication digitale avec le protocole HART®.

Caractéristiques techniques :

- Le PR5335 peut être programmé de manière simple et rapide.
- Compensation de ligne pour des entrées RTD et résistance avec un raccordement à 2, 3 et 4 fils.
- Vérification continue des données sauvegardés.
- Détection de rupture sonde selon les recommandations NAMUR NE 89.

Montage / installation :

- Pour tête de sonde DIN B. En zone non-dangereuse le 5335 peut être monté sur rail DIN avec un support spécifique.
- **N.B.:** Comme barrière S.I. pour le 5335B, C et D nous recommandons le PR5106B.

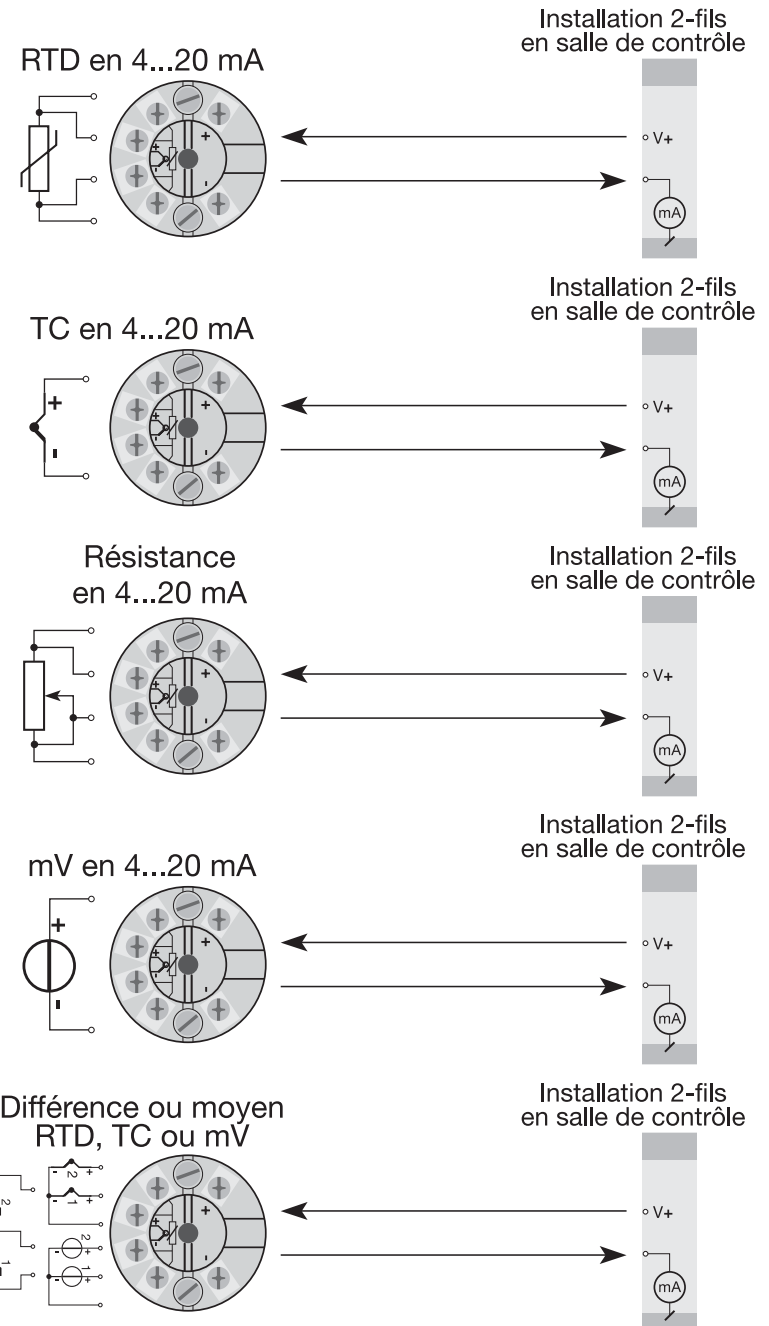

Référence : 5335

Type	Version
5335	Standard : A
	ATEX : B
	FM et ATEX : C
	CSA, FM et ATEX : D

Spécifications électriques :

Plage des spécifications :

-40°C à +85°C

Spécifications communes :

Tension d'alimentation cc

Standard. 5335A 8,0...35 V

ATEX, 5335B 8,0...30 V

FM et CSA, 5335C et D 8,0...28 V

Tension d'isolation, test / opération 1,5 kVca / 50 Vca

Temps de chauffe 30 s

Kit de programmation HART® et Loop Link

Rapport signal / bruit Min. 60 dB

Temps de réponse (programmable) 1...60 s

Vérification de l'EEPROM < 10 s

Dynamique du signal d'entrée 22 bit

Dynamique du signal de sortie 16 bit

Température d'étalonnage 20...28°C

Précision, la plus grande des valeurs générales et de base :

Valeurs générales		
Type d'entrée	Précision absolue	Coefficient de température
Tous	≤ ±0,05% de l'EC	≤ ±0,005% de l'EC / °C

Valeurs de base		
Type d'entrée	Précision de base	Coefficient de température
Pt100 et Pt1000	≤ ±0,1°C	≤ ±0,005°C/°C
Ni100	≤ ±0,2°C	≤ ±0,005°C/°C
R. Lin.	≤ ±0,1 Ω	≤ ±5 mΩ/°C
Volt	≤ ±10 μV	≤ ±0,5 μV/°C
Type TC : E, J, K, L, N, T, U	≤ ±0,5°C	≤ ±0,025°C/°C
Type TC : B, R, S, W3, W5	≤ ±1°C	≤ ±0,1°C/°C

Immunité CEM..... < ±0,1% de l'EC

Immunité CEM améliorée :

NAMUR NE 21, critère A, burst < ±1% de l'EC

Effet d'une variation

de la tension d'alimentation < 0,005% de l'EC / Vcc

Vibration IEC 60068-2-6 Test FC

Lloyd specification no. 1 4 g / 2...100 Hz

Taille max. des fils 1 x 1,5 mm² fil multibrins

Humidité < 95% HR (sans cond.)

Dimensions Ø 44 x 20,2 mm

Étanchéité (boîtier / bornier) IP68 / IP00

Poids 50 g

Spécifications électriques, entrée :

Décalage max. 50% de la valeur num. max. sélec.

Entrée RTD et entrée résistance linéaire :

Type RTD	Température min.	Température max.	Plage min.
Pt100	-200°C	+850°C	10°C
Ni100	-60°C	+250°C	10°C
R. Lin.	0 Ω	7000 Ω	25 Ω

Résistance de ligne max. par fil 5 Ω

Courant de sonde Nom. 0,2 mA

Effet de la résistance de ligne (3- / 4-fils) < 0,002 Ω/Ω

Détection de rupture sonde Oui
 Détection de court-circuit Si 0% > 30 Ω

Entrée TC :

Type	Température min.	Température max.	Plage min.	Norme
B	+400°C	+1820°C	100°C	IEC584
E	-100°C	+1000°C	50°C	IEC584
J	-100°C	+1200°C	50°C	IEC584
K	-180°C	+1372°C	50°C	IEC584
L	-100°C	+900°C	50°C	DIN 43710
N	-180°C	+1300°C	50°C	IEC584
R	-50°C	+1760°C	100°C	IEC584
S	-50°C	+1760°C	100°C	IEC584
T	-200°C	+400°C	50°C	IEC584
U	-200°C	+600°C	50°C	DIN 43710
W3	0°C	+2300°C	100°C	ASTM E988-90
W5	0°C	+2300°C	100°C	ASTM E988-90

Compensation de soudure froide (CSF) < ±1,0°C
 CSF externe avec Ni100 ou Pt100 -40 ≤ T_{amb.} ≤ 135°C
 Détection de rupture sonde Oui

Courant de sonde :

Pendant la détection..... Nom. 33 µA
 Si non..... 0 µA
 Détection de court-circuit Si 0% > 5 mV

Entrée tension :

Gamme de mesure..... -800...+800 mV
 Plage de mesure min. 2,5 mV
 Résistance d'entrée 10 MΩ

Sortie courant :

Gamme de mesure..... 4...20 mA
 Plage de mesure min. 16 mA
 Temps de scrutation..... 440 ms
 (660 ms pour diff.)
 Signal sortie fixe..... Entre 4 et 20 mA
 Sortie en cas de corruption de l'EEPROM..... ≤ 3,5 mA
 Résistance de charge..... ≤ (V_{alim.} - 8) / 0,023 [Ω]
 Stabilité de charge < ±0,01% de l'EC / 100 Ω

Détection de rupture de sonde :

Programmable..... 3,5...23 mA
 NAMUR NE43 Haut d'échelle 23 mA
 NAMUR NE43 Bas d'échelle..... 3,5 mA

Caractéristiques S.I. :

Sortie signal / alimentation, borne 1 à 2:

U_i..... : 30 Vcc
 I_i..... : 120 mA_{Acc}
 P_i..... : 0,84 W
 L_i..... : 10 µH
 C_i..... : 1,0 nF

Entrée capteur, borne 3, 4, 5 et 6:

U_o..... : 9,6 Vcc
 I_o..... : 28 mA
 P_o..... : 67 mW
 L_o..... : 35 mH
 C_o..... : 3,5 µF

Approbation EEx / S.I. 5335A:

Kema 03ATEX1508 X  II 3 GD
 EEx nA[L] IIC T4 ou T6

Approbation EEx / S.I. 5335B, C et D :

KEMA 03 ATEX 1537 X  II 1 GD, T80°C...T105°C

EEx ia IIC T6 / T4

Température amb. max. (T1...T4) 85°C

Température amb. max. (T5 et T6)..... 60°C

ATEX, applicable en zone..... 0, 1, 2, 20, 21 ou 22

FM, applicable en IS, Class I, DIV. 1, Group A, B, C, D
 IS, Class I, Zone 0, AEx ia IIC

Entity, FM Installation Drawing No. 5300Q502

CSA, applicable en IS, Class I, DIV. 1, Group A, B, C, D,
 Ex ia IIC

IS, Class I, Zone 0, AEx ia IIC

Installation Drawing No. 533XQC03

Approbation marine :

Det Norske Veritas, Ships & Offshore Standard for Certification No. 2.4

Agréments et homologations : **Standard :**

EMC 2004/108/CE

Emission et immunité EN 61326

ATEX 94/9/CE..... EN 50014, EN 50020, EN 50021

EN 50281-1-1 et 50284

FM, ASCN 3600, 3611, 3610

CSA, CAN / CSA C22.2 No. 157, E60079-11, UL 913

EC = Echelle configurée

Connexions :

Entrée :

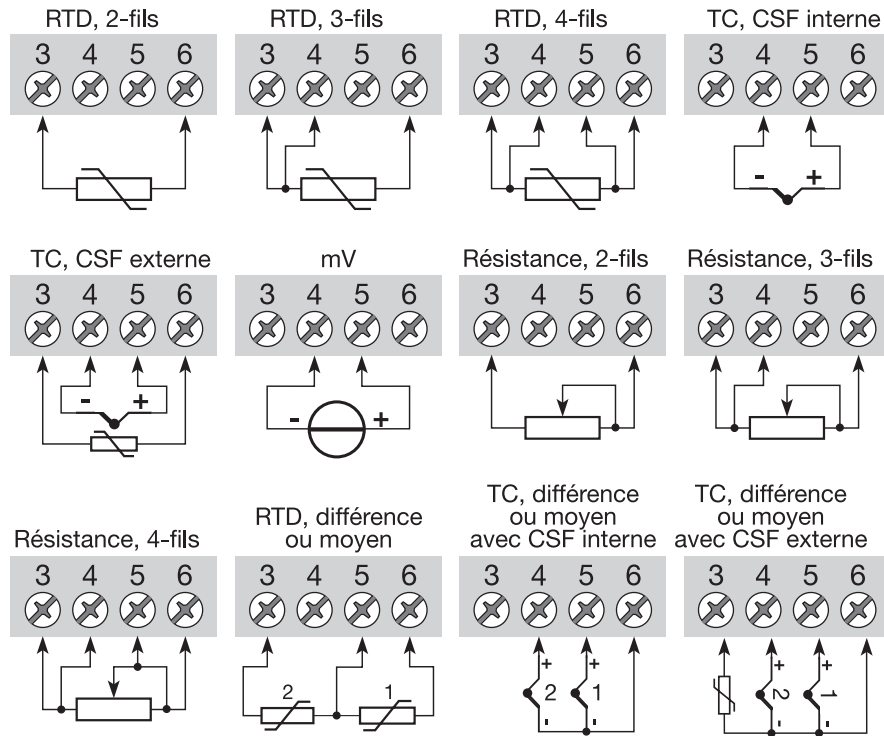

Sortie :

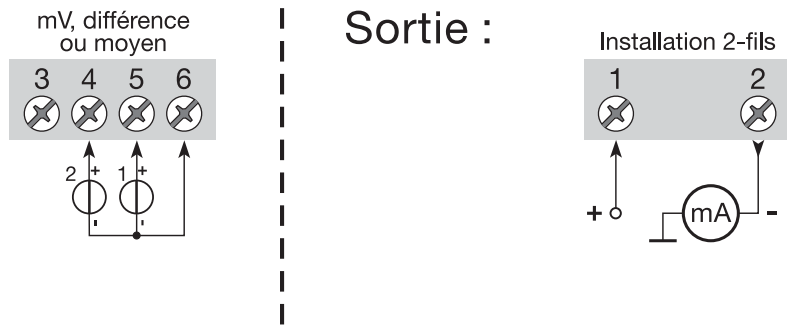

SCHEMA DE PRINCIPLE :

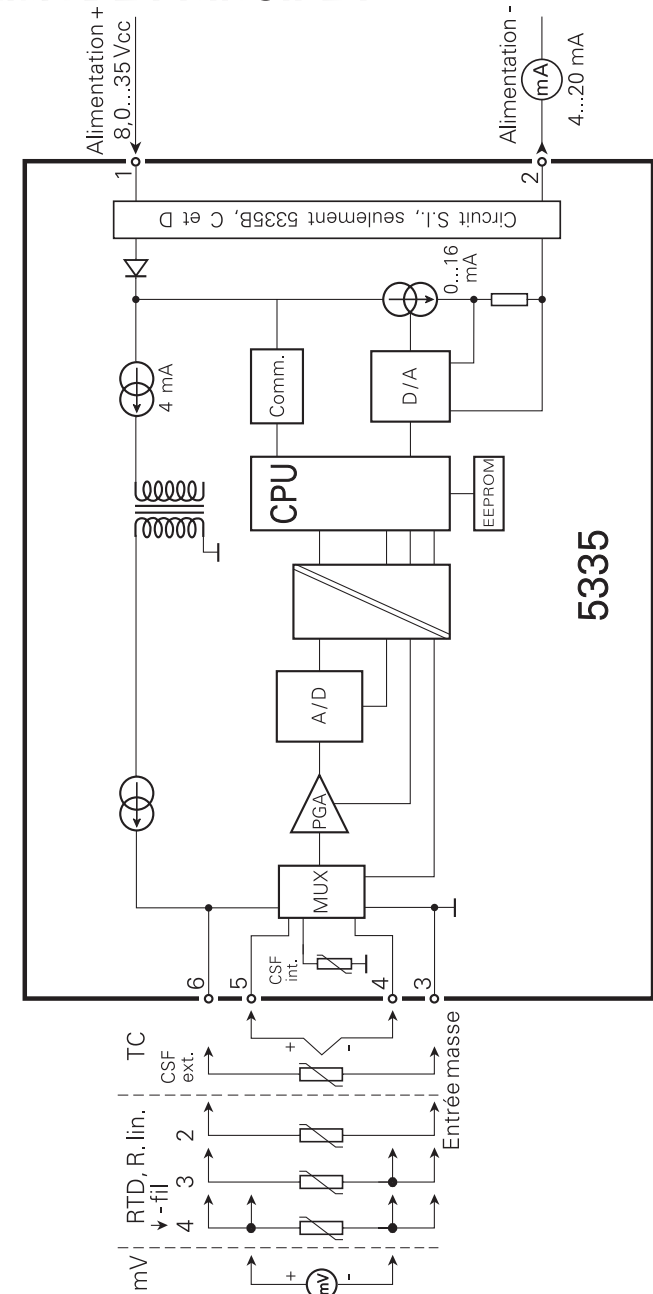

Programmation :

Le PRetop 5335 peut être programmé des 3 manières suivantes :

- 1 Avec le kit de programmation Loop Link et le logiciel PReset de PR electronics A/S.
2. Avec le modem HART® et le logiciel PReset.
3. Avec le communicateur HART® chargé avec le DDL de PR electronics A/S.

1 : Loop Link :

Pour le raccordement du Loop Link, veuillez vous reporter au schéma ci-dessous et à l'aide en ligne du logiciel PReset.
Loop Link ne doit pas être utilisé pour communication avec des modules installés en zone dangereuse.

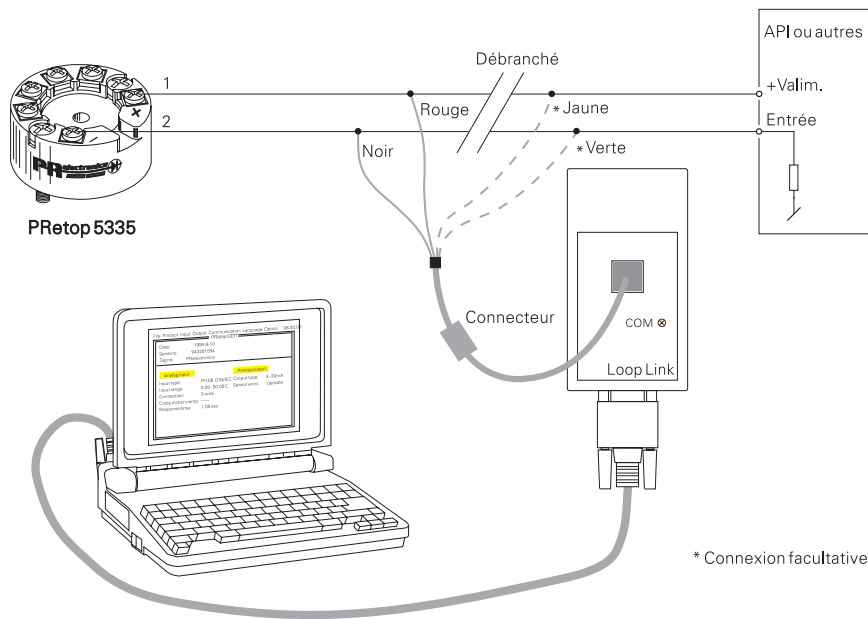

2 : Modem HART® :

Pour le raccordement veuillez vous reporter au schéma ci-dessous et à l'aide en ligne du logiciel PReset.

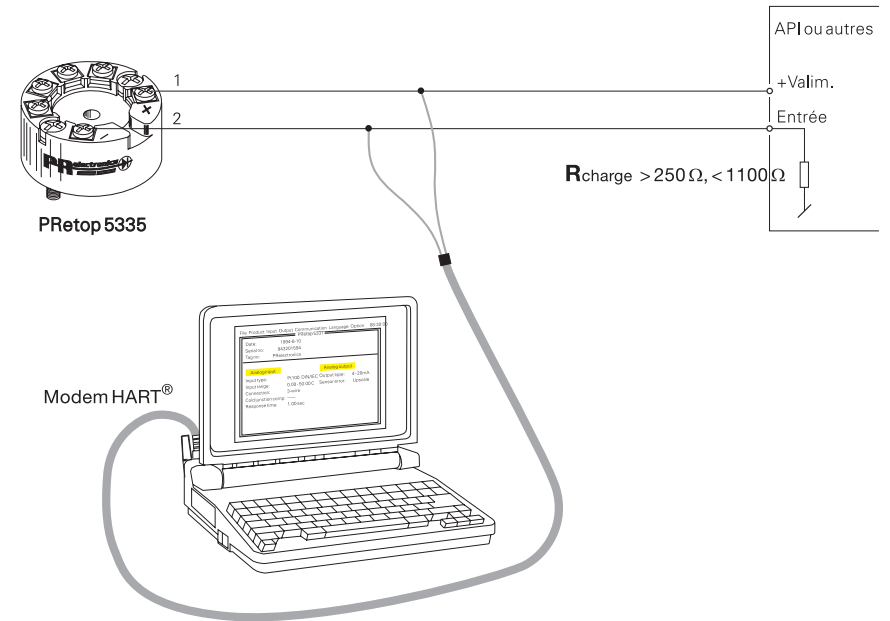

3 : Communicateur HART® :

Pour le raccordement veuillez vous reporter au schéma ci-dessous. Pour avoir accès à tous les paramètres, le communicateur HART® doit être chargé avec le DDL spécifique du PR electronics A/S. Ce DDL peut être commandé chez PR electronics A/S ou chez la Fondation HART®.

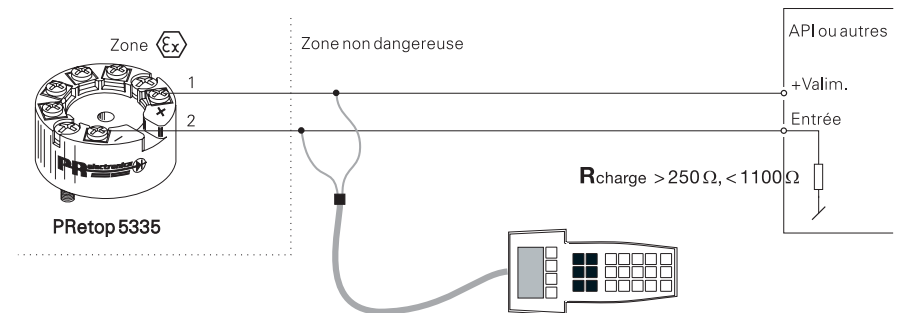

Raccordement des transmetteurs en multi-adressage :

Le communicateur HART® ou le modem peuvent être connectés sur les points AB ou sur les points BC.

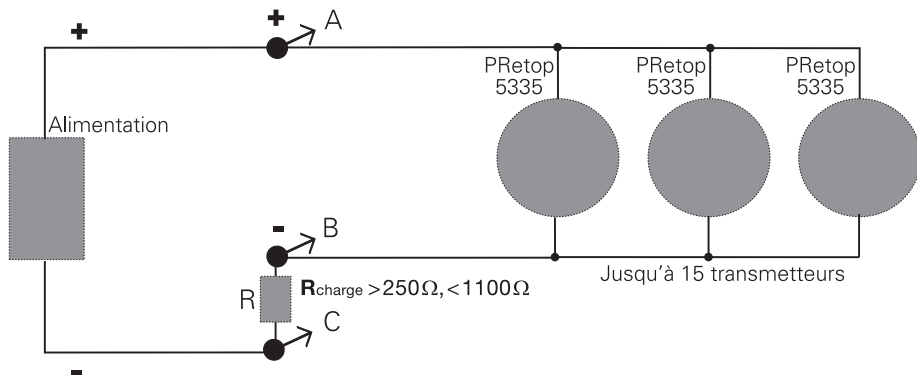

Pour la communication digitale HART® de 2-fils, les sorties de 15 transmetteurs au maximum peuvent être connectés en parallèle.

Chaque transmetteur sera doté d'un numéro unique entre 1 et 15. Si 2 transmetteurs ont le même numéro, tous les deux seront ignorés. Programmés pour multi-adressage, les sorties des transmetteurs seront bloquées à 4 mA, et le courant max. dans la boucle sera donc de 60 mA.

La communication se fait ensuite soit avec le communicateur HART® ou le modem HART®.

Le logiciel PReset peut configurer le transmetteur individuel en multi-adressage et lui donner un adressage unique.

Dimensions mécaniques :

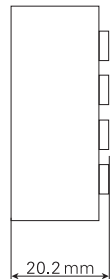
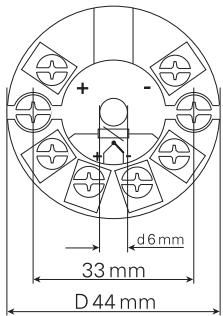

Montage des fils du capteur

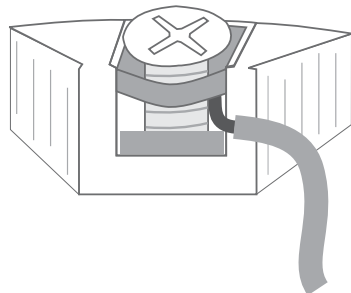

Les fils doivent être montés entre les plaques métalliques.

2-DRAHT MESSUMFORMER MIT HART® PROTOKOLL

PRetop 5335

Inhaltsverzeichnis

Sicherheitsinstruktion	44
Konformitätserklärung	45
Verwendung.....	46
Technische Merkmale.....	46
Montage / Installation.....	46
Anwendungen	47
Bestellangaben.....	48
Elektrische Daten	48
Anschlüsse	52
Blockdiagramm	53
Programmierung.....	54
Parallelanschluss von Signalgebern (Multidrop)	56
Abmessungen	56
Montage von Fühlerleitungen.....	56
Appendix:	
FM Installation Drawing No. 5300Q502	58
CSA Installation Drawing No. 533XQC03	60

Sicherheitsinstruktion

Ex-Installation:

Für sichere Installation von 5335B in explosionsgefährdeter Umgebung muss folgendes beobachtet werden. Die Installation muss nur von qualifizierten Personen, die mit den nationalen und internationalen Gesetze, Direktiven und Standards des Gebiets bekannt sind, vorgenommen werden.

Die ersten beiden Ziffern der Seriennummer geben das Produktionsjahr an.

Für Einbauvorschriften und Ex-Daten siehe ATEX-zertifikate.

KONFORMITÄTSERKLÄRUNG

Als Hersteller bescheinigt

PR electronics A/S

Lerbakken 10

DK-8410 Rønde

hiermit für das folgende Produkt:

Typ: 5335

Name: 2-Draht Messumformer mit HART® Protokoll

die Konformität mit folgenden Richtlinien und Normen:

EMV Richtlinien 2004/108/EG und nachfolgende Änderungen

EN 61326

Diese Erklärung ist in Übereinstimmung mit Artikel 10, Unterklausel 1 der EMV Richtlinie ausgestellt. Zur Spezifikation des zulässigen Erfüllungsgrades, siehe die Elektrische Daten des Moduls.

Die ATEX Richtlinien 94/9/EG und nachfolgende Änderungen

EN 50014, EN 50020, EN 50021,

EN 50281-1-1 und EN 50284

ATEX-Zertifikat: KEMA 03ATEX1508 X (5335A)

ATEX-Zertifikat: KEMA 03ATEX1537 X (5335B, C und D)

Zulassungsstelle für CENELEC/ATEX: **UL International Demko A/S 0539**

Rønde, 17. Nov. 2005



Peter Rasmussen
Unterschrift des Herstellers

2-DRAHT MESSUMFORMER MIT HART® PROTOKOLL PRetop 5335

- Eingang für WTH, TE, Ω oder mV
- Extreme Messgenauigkeit
- HART® Kommunikation
- Galvanische Trennung
- Für Einbau in Anschlusskopf DIN Form B

Verwendung:

- Linearisierte Temperaturmessung mit Pt100...Pt1000, Ni100...Ni1000 oder Thermoelementsensoren.
- Temperaturdifferenzen oder eine Durchschnittstemperaturmessung von 2 Widerstands- oder TE-Sensoren.
- Umwandlung von linearer Widerstandsänderung in ein analoges Standard-Stromsignal, z.B. von Ventilen oder Niveau-Messwertgeber.
- Verstärkung von bipolaren mV-Signalen zu einem Standard 4...20 mA Stromsignal.
- Bis zu fünfzehn Umformer können in einem Multidrop-System parallel verbunden werden mit HART® Kommunikation.

Technische Merkmale:

- PR5335 kann vom Benutzer innerhalb von wenigen Sekunden zur Messung in allen genormten Temperaturbereiche programmiert werden.
- Der WTH- und Widerstandseingang haben Leitungskompensation bei 2-, 3- oder 4-Leiter-Anschluss.
- Die gespeicherten Daten werden laufend kontrolliert.
- Fehlerfehlererkennung in Übereinstimmung mit der Richtlinien der NAMUR NE 89.

Montage / Installation:

- Für DIN Form B Sensorkopf Montage. Im sicheren Bereich kann der 5335 auf einer DIN-Schiene mittels einer spezieller Armatur montiert werden.
- **NB:** Als Ex-Sicherheitsbarriere für 5335B, C und D empfehlen wir 5106B.

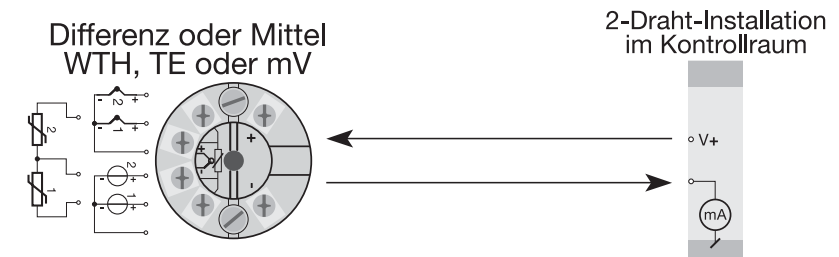
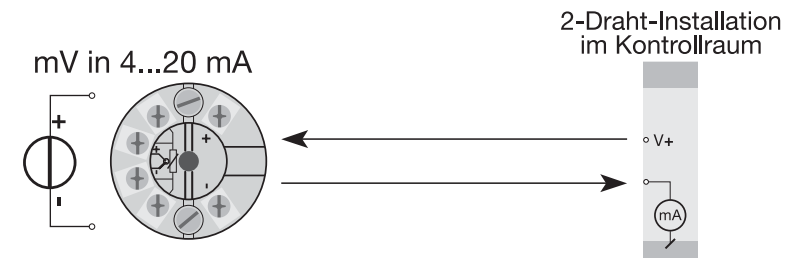
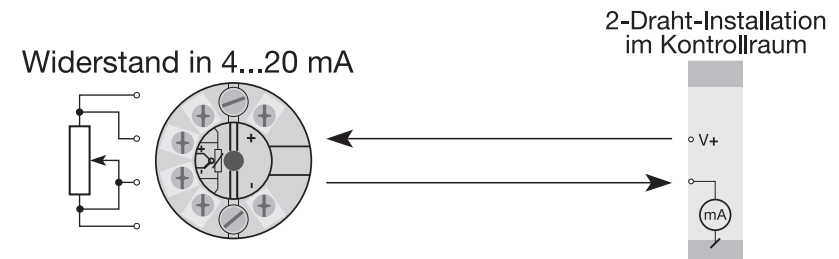
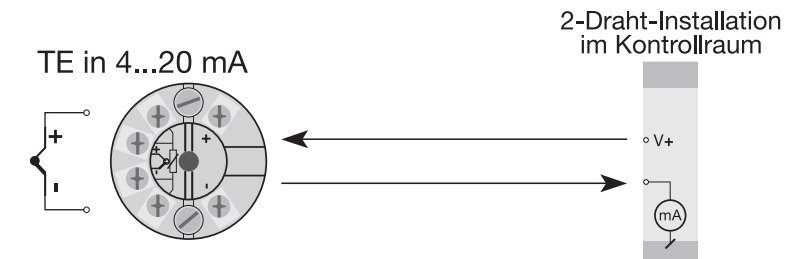
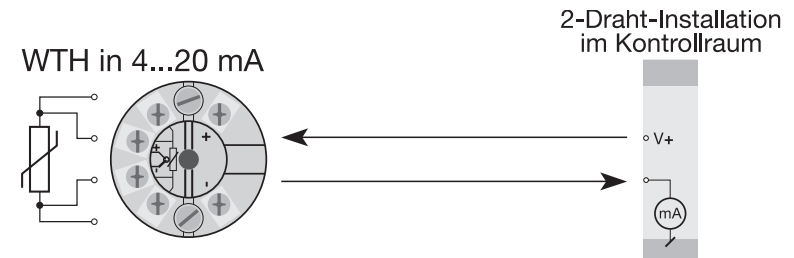

Bestellangaben: 5335

Typ	Version
5335	Standard : A
	ATEX : B
	FM und ATEX : C
	CSA, FM und ATEX : D

Elektrische Daten:

Spezifikationsbereich:

-40°C bis +85°C

Gemeinsame Daten:

Versorgungsspannung, DC

Standard, 5335A 8,0...35 V

ATEX, 5335B 8,0...30 V

FM und CSA, 5335C und D 8,0...28 V

Isolationsspannung, Test / Betrieb 1,5 kVAC / 50 VAC

Aufwärmzeit 30 s

Kommunikationsschnittstelle HART® und Loop Link

Signal- / Rauschverhältnis Min. 60 dB

Ansprechzeit (programmierbar) 1...60 s

EEProm Fehlerkontrolle < 10 s

Signaldynamik, Eingang 22 Bit

Signaldynamik, Ausgang 16 Bit

Kalibrierungstemperatur 20...28°C

Genauigkeit, höherer Wert von allgemeinen und Grundwerten:

Allgemeine Werte		
Eingangsart	Absolute Genauigkeit	Temperaturkoeffizient
Alle	≤ ±0,05% d. Messsp.	≤ ±0,005% d. Messsp./°C

Grundwerte		
Eingangsart	Grund-Genauigkeit	Temperaturkoeffizient
Pt100 und Pt1000	≤ ±0,1°C	≤ ±0,005°C/°C
Ni100	≤ ±0,2°C	≤ ±0,005°C/°C
Lin. R	≤ ±0,1 Ω	≤ ±5 mΩ/°C
Volt	≤ ±10 µV	≤ ±0,5 µV/°C
TE-Typ: E, J, K, L, N, T, U	≤ ±0,5°C	≤ ±0,025°C/°C
TE-Typ: B, R, S, W3, W5	≤ ±1°C	≤ ±0,1°C/°C

EMV-Immunitätswirkung < ±0,1% d. Messsp.
Erweiterte EMV-Immunität:
NAMUR NE 21, A Kriterium, Burst < ±1% d. Messsp.

Einfluss von Änderung der

Versorgungsspannung < 0,005% d. Messsp. / VDC

Vibration IEC 60068-2-6 Test FC

Lloyd's Spezifikation Nr. 1 4 g / 2...100 Hz

Max. Leitungsquerschnitt 1 x 1,5 mm² Litzendraht

Luftfeuchtigkeit < 95% RH (nicht kond.)

Maß Ø 44 x 20,2 mm

Dichtheit (Gehäuse / Anschluss) IP68 / IP00

Gewicht 50 g

Elektrische Daten, Eingang:

Max. Nullpunktverschiebung (Offset) 50% des gew. num. Max.-Wertes

WTH- und Linearer Widerstandseingang:

WTH-Typ	Min. Wert	Max. Wert	Min. Spanne
Pt100	-200°C	+850°C	10°C
Ni100	-60°C	+250°C	10°C
Lin. R	0 Ω	7000 Ω	25 Ω

Leitungswiderstand pro Leiter (Max.) 5 Ω

Sensorstrom Nom. 0,2 mA

Wirkung des Fühlerkabelwiderstandes

(3- / 4-Leiter) < 0,002 Ω/Ω

Fühlerfehlererkennung..... Ja
 Kurzschlusserkennung..... Falls 0% > 30 Ω

TE-Eingang:

Typ	Min. Temperatur	Max. Temperatur	Min. Spanne	Norm
B	+400°C	+1820°C	100°C	IEC584
E	-100°C	+1000°C	50°C	IEC584
J	-100°C	+1200°C	50°C	IEC584
K	-180°C	+1372°C	50°C	IEC584
L	-100°C	+900°C	50°C	DIN 43710
N	-180°C	+1300°C	50°C	IEC584
R	-50°C	+1760°C	100°C	IEC584
S	-50°C	+1760°C	100°C	IEC584
T	-200°C	+400°C	50°C	IEC584
U	-200°C	+600°C	50°C	DIN 43710
W3	0°C	+2300°C	100°C	ASTM E988-90
W5	0°C	+2300°C	100°C	ASTM E988-90

Vergleichstellenkompensation (CJC)..... < ±1,0°C
 Externe CJC mit Ni100 oder Pt100 -40 ≤ T_{Umg.} ≤ 135°C
 Fühlerfehlererkennung..... Ja

Fühlerfehlerstrom:
 Bei Erkennung..... Nom. 33 µA
 Sonst..... 0 µA
 Kurzschlusserkennung Falls 0% > 5 mV

Spannungseingang:

Messbereich -800...+800 mV
 Min. Messbereich (Spanne)..... 2,5 mV
 Eingangswiderstand 10 MΩ

Stromausgang:

Signalbereich..... 4...20 mA
 Min. Signalbereich..... 16 mA
 Aktualisierungszeit 440 ms
 (660 ms für Diff.)
 Festes Ausgangssignal Zwischen 4 und 20 mA
 Ausgangssignal bei EEpromfehler ≤ 3,5 mA
 Belastungswiderstand..... ≤ (U_{Versorg.} - 8) / 0,023 [Ω]
 Belastungsstabilität < ±0,01% d. Messsp. / 100 Ω

Sensorfehlanzeige:

Programmierbar 3,5...23 mA
 NAMUR NE43 aufsteuernd 23 mA
 NAMUR NE43 zusteuernd 3,5 mA

Ex- / I.S.-Daten:

Signalausgang / Versorgung, Klemmen 1 bis 2:
 U_i..... : 30 VDC
 I_i..... : 120 mADC
 P_i..... : 0,84 W
 L_i..... : 10 µH
 C_i..... : 1,0 nF

Fühlereingang, Klemmen 3, 4, 5 und 6:

U_o..... : 9,6 VDC
 I_o..... : 28 mA
 P_o..... : 67 mW
 L_o..... : 35 mH
 C_o..... : 3,5 µF

EEEx- / I.S.-Zulassung 5335A:

Kema 03ATEX1508 X  II 3 GD
 EEx nA[L] IIC T4 oder T6

EEx / I.S.-Zulassung 5335B, C und D:

KEMA 03ATEX1537 X.....  II 1 GD, T80°C...T105°C
 EEx ia IIC T6 / T4
 Max. Umgebungstemp. für T1...T4..... 85°C
 Max. Umgebungstemp. für T5 und T6..... 60°C
ATEX, für Anwendung in Zone..... 0, 1, 2, 20, 21 oder 22
FM, für Anwendung in..... IS, Class I, DIV. 1, Group A, B, C, D
 IS, Class I, Zone 0, AEx ia IIC
 Entity, FM Installation Drawing No..... 5300Q502
CSA, für Anwendung in IS, Class I, DIV. 1, Group A, B, C, D,
 Ex ia IIC
 Class I, Zone 0, AEx ia IIC
 Installation Drawing No. 533XQC03

Marine-Zulassung:

Det Norske Veritas, Ships & Offshore Standard for Certification No. 2.4

Eingehaltene Behördenvorschriften: Norm:

EMV 2004/108/EG
 Emission und Immunität..... EN 61326
 ATEX 94/9/EG..... EN 50014, EN 50020, EN 50021,
 EN 50284 und EN 50281-1-1
 FM, ASCN 3600, 3611, 3610
 CSA, CAN / CSA C22.2 No. 157, E60079-11, UL 913

d. Messspanne = der gewählten Messspanne

Anschlüsse:

Eingang:

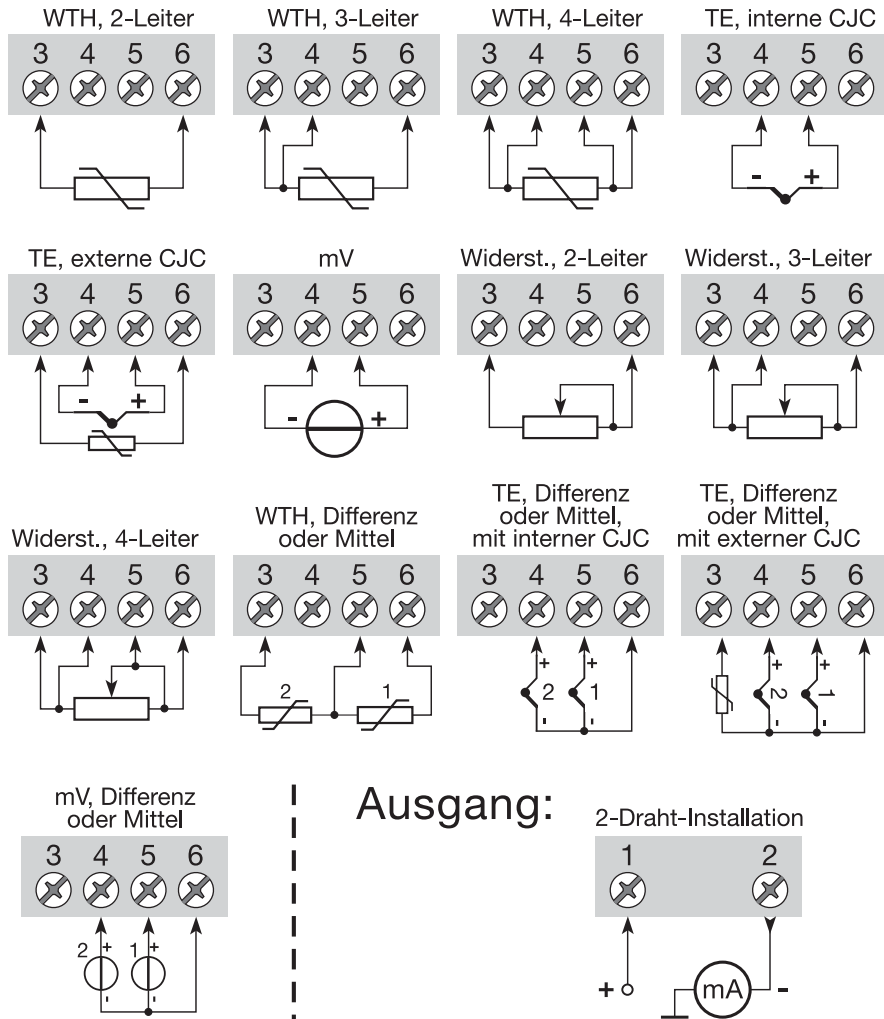

Ausgang:

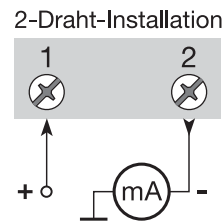

BLOCKDIAGRAMM:

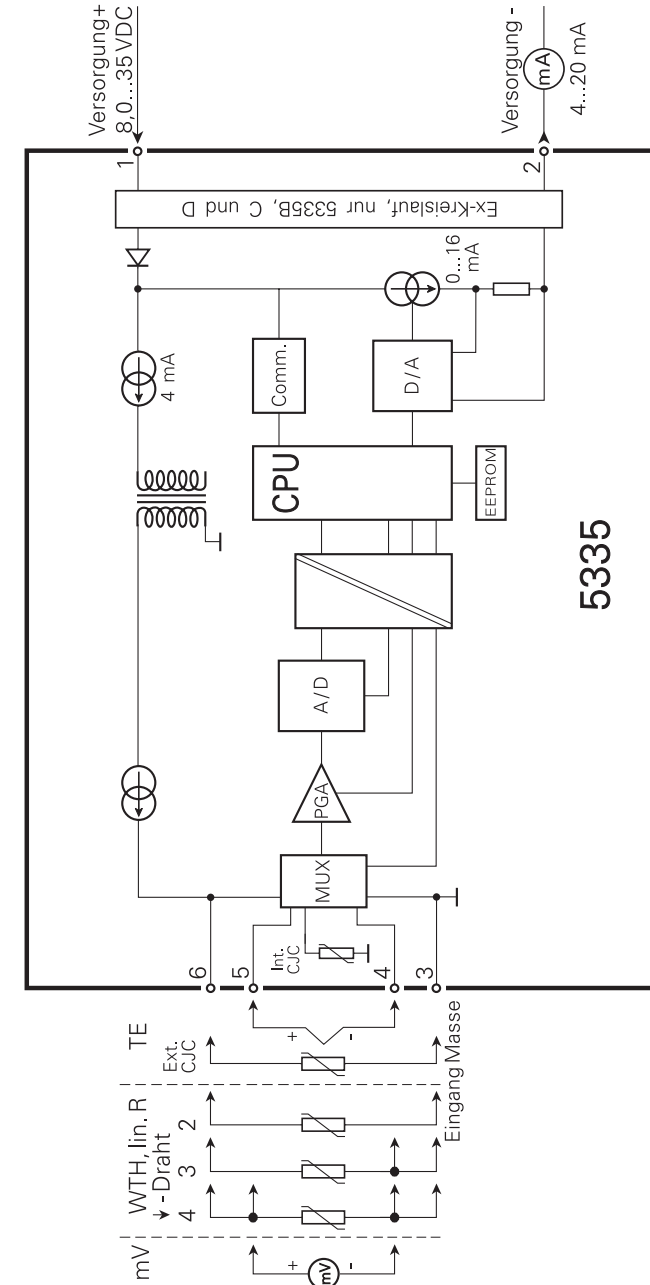

Programmierung:

PRetop 5335 kann in 3 verschiedener Weise programmiert werden:

1. Mittels PR electronics A/S' Kommunikationsschnittstelle Loop Link und PReset PC Programmierungssoftware.
2. Mittels HART® Modem und PReset PC Programmierungssoftware.
3. Mittels HART® Datenaustauschgerät mit PR electronics A/S' DDL-Antrieb.

1: Loop Link:

Bezüglich Programmierung verweisen wir auf die nachfolgende Zeichnung und die "Hilfe"-Funktion im PReset-Programm.

Loop Link darf nicht zur Kommunikation mit Modulen, die in Ex-gefährdeten bereichen installiert sind, benutzt werden.

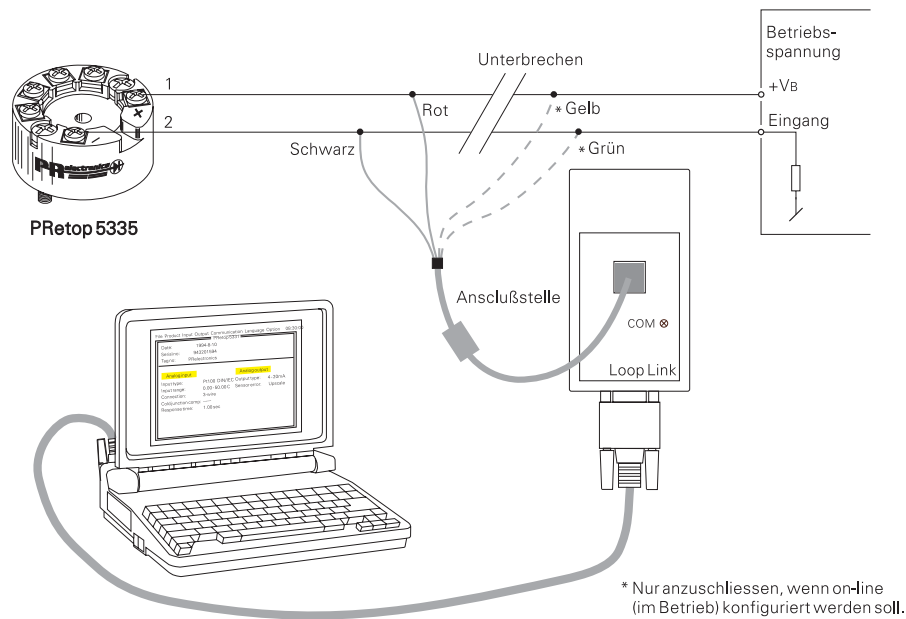

2: HART® Modem:

Bezüglich Programmierung verweisen wir auf die nachfolgende Zeichnung und die "Hilfe"-Funktion im PReset-Programm.

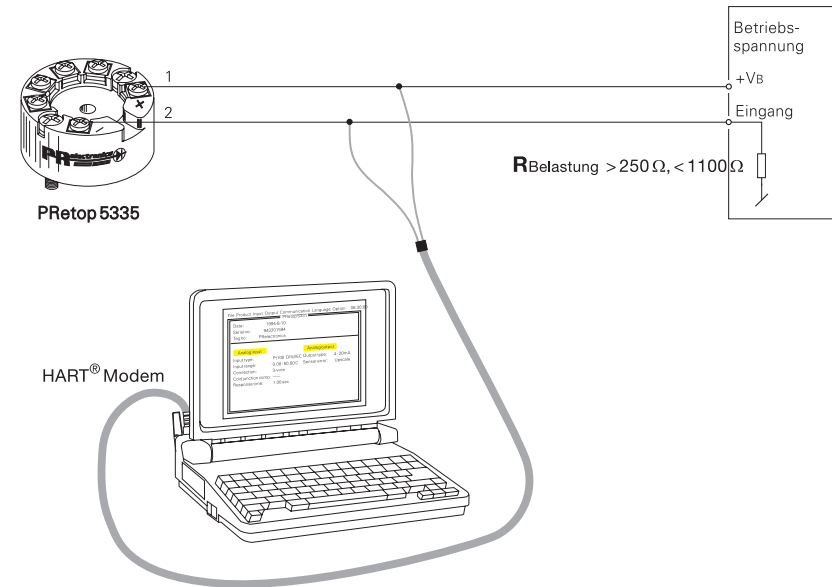

3: HART® Datenaustauschgerät:

Bezüglich Programmierung verweisen wir auf die nachfolgende Zeichnung. Um Zutritt zur Produktspezifischen Kommandos zu bekommen, muss das HART® Datenaustauschgerät mit dem DDL-Antrieb von PR electronics A/S ausgestattet sein. Der Antrieb ist von HART® Communication Foundation oder PR electronics A/S erhältlich.

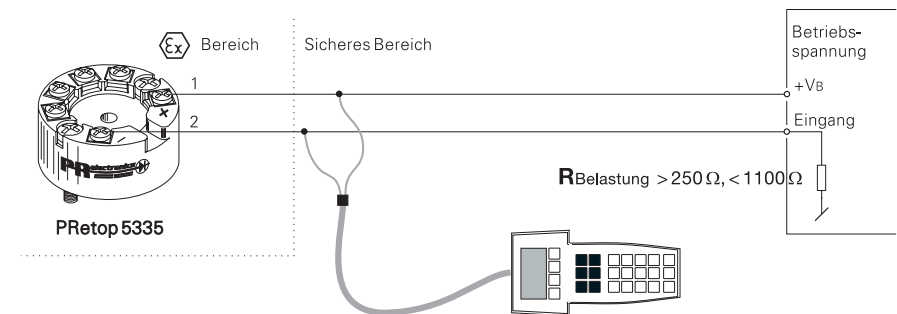

Parallelanschluss von Signalgebern (Multidrop):

Ein HART® Datenaustauschgerät oder ein PC-Modem kann über die Punkte AB oder BC angeschlossen werden.

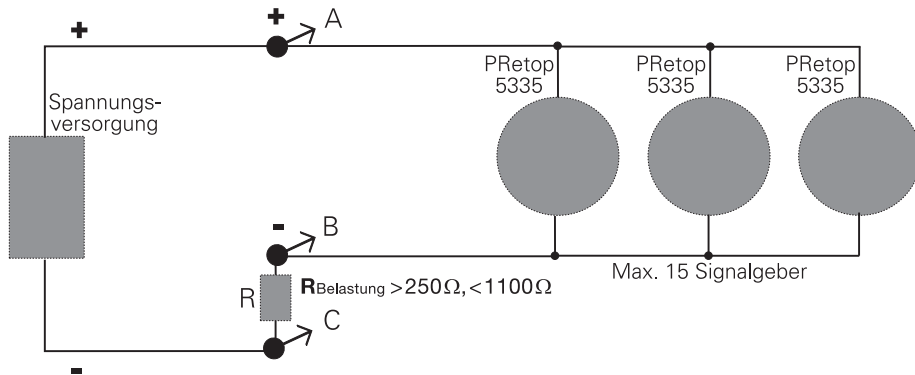

Im Ausgang können bis zu 15 Signalgeber für eine digitale Kommunikation über Zweileiter parallel geschaltet werden.

Jeder Signalgeber wird mit einer unverwechselbaren Nummer von 1 bis 15 konfiguriert. Wenn 2 Signalgeber mit der selben Nummer konfiguriert sind, werden sie beide ignoriert. Die Signalgeber müssen auf Multidropmodus (mit einem festen Ausgangssignal von 4 mA) programmiert werden. Der maximale Strom in der Schleife kann somit 60 mA betragen.

Die Kommunikation kann über ein HART®-Datenaustauschgerät oder HART®-Modem erfolgen.

Die PReset Software kann den einzelnen Signalgeber auf Multidropmodus einstellen und ihm eine unverwechselbare Adresse für wiederkehrende Abfrage (polling) zuteilen.

Abmessungen:

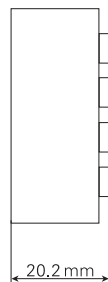
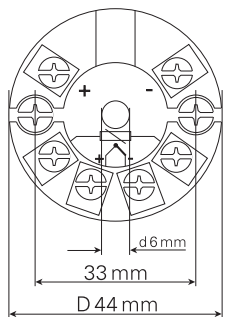

Montage von Fühlerleitungen:

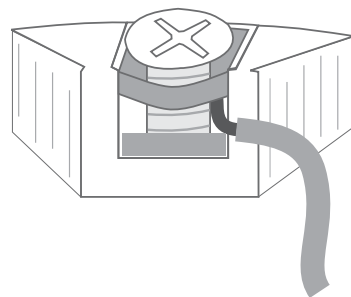

Die Leitungen müssen zwischen den Metallplatten montiert werden.

APPENDIX

FM Installation Drawing No. 5300Q502

CSA Installation Drawing No. 533XQC03

Installation Drawing 5300Q502.

The entity concept.

The Transmitter must be installed according to National Electrical Code (ANSI-NFPA 70).

When installed in Class II locations the Transmitter shall be installed in an enclosure with a specified ingress protections of IP6X according to IEC60529 and Dust-tight conduit seals must be used.

Equipment that is FM-approved for intrinsic safety may be connected to barriers based on the ENTITY CONCEPT. This concept permits interconnection of approved transmitters, meters and other devices in combinations which have not been specifically examined by FM, provided that the agency's criteria are met. The combination is then intrinsically safe, if the entity concept is acceptable to the authority having jurisdiction over the installation.

The entity concept criteria are as follows:

The intrinsically safe devices, other than barriers, must not be a source of power. The maximum voltage $U_i(V_{MAX})$ and current $I_i(I_{MAX})$, and maximum power $P_i(P_{max})$, which the device can receive and remain intrinsically safe, must be equal to or greater than the voltage (U_o or V_{oc} or V_t) and current (I_o or I_{sc} or I_t) and the power P_o which can be delivered by the barrier.

The sum of the maximum unprotected capacitance (C) for each intrinsically device and the interconnecting wiring must be less than the capacitance (C_a) which can be safely connected to the barrier.

The sum of the maximum unprotected inductance (L) for each intrinsically device and the interconnecting wiring must be less than the inductance (L_a) which can be safely connected to the barrier.

The entity parameters U_o, V_{oc} or V_t and I_o, I_{sc} or I_t , and C_a and L_a for barriers are provided by the barrier manufacturer.

Model 5331C, 5331D, 5333C and 5333D

Hazardous (Classified) Location
Class I, Division 1, Groups, A, B, C, D
Class II Division 1 Groups E, F, G or
Class I, Zone 0, IIC

Ambient temperature limits
T4: -40 to +85 deg. Celcius
T6: -40 to +60 deg. Celcius

Terminal 1, 2
 V_{max} or U_i : 28 V
 I_{max} or I_i : 120 mA
 P_{max} or P_i : 0.84 W
 C_i : 1 nF
 L_i : 10 uH

Terminal 3, 4, 5, 6
Only passive, or non-energy storing devices such as RTD's and Thermocouples may be connected.

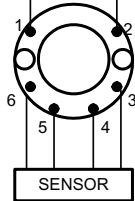

5333D Non Hazardous Location

Associated Apparatus or Barrier with entity Parameters:

$U_M \leq 250V$
 V_{oc} or $U_o \leq V_{max}$ or U_i
 I_{sc} or $I_o \leq I_{max}$ or I_i
 $P_o \leq P_i$
 C_a or $C_o \geq C_i + C_{cable}$
 L_a or $L_o \geq L_i + L_{cable}$

This device must not be connected to any associated apparatus which uses or generates more than 250 VRMS

Model 5335C, 5335D.

Hazardous (Classified) Location

Class I, Division 1, Groups, A, B, C, D
Class II Division 1 Groups E, F, G or
Class I, Zone 0, IIC

Ambient temperature limits
T4: -40 to +85 deg. Celcius
T6: -40 to +60 deg. Celcius

Terminal 1, 2
 V_{max} or U_i : 28 V
 I_{max} or I_i : 120 mA
 P_{max} or P_i : 0.84 W
 C_i : 1 nF
 L_i : 10 uH

Terminal 3, 4, 5, 6
 V_t or U_o : 9.6 V
 I_t or I_o : 28 mA
 P_t or P_o : 67.2 mW
 C_a or C_o : 3.5 uF
 L_a or L_o : 35 mH

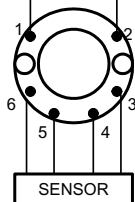

5335D Non Hazardous Location

Associated Apparatus or Barrier with entity Parameters:

$U_M \leq 250V$
 V_{oc} or $U_o \leq V_{max}$ or U_i
 I_{sc} or $I_o \leq I_{max}$ or I_i
 $P_o \leq P_i$
 C_a or $C_o \geq C_i + C_{cable}$
 L_a or $L_o \geq L_i + L_{cable}$

This device must not be connected to any associated apparatus which uses or generates more than 250 VRMS

CSA Intrinsic Safety Installation Drawing.

5331D, 5333D and 5335D transmitters are approved as intrinsically safe in Zone 0 Group IIC or Class I, Division 1, Group A, B, C, D when installed according to Installation Drawing.

1. Connections with separate power supply and receiver.

Output: Standard 4 - 20mA loop

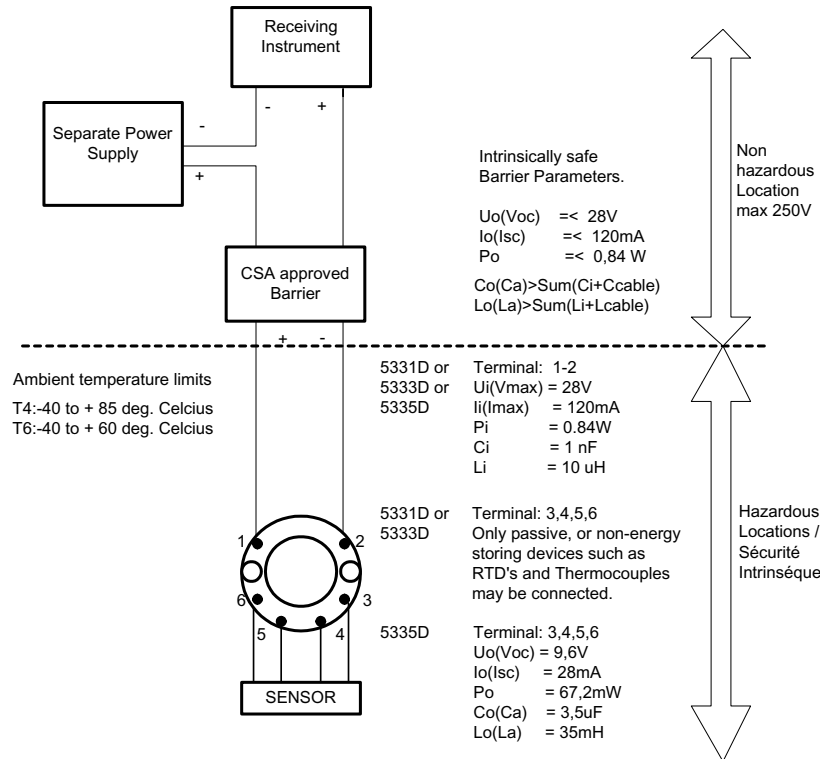

Warning:

Substitution of components may impair intrinsic safety.

The transmitters must be installed in a suitable enclosure to meet installation codes stipulated in the Canadian Electrical Code (CEC).

2. Connection with power supply and barrier built into receiver.

Output: Standard 4 - 20mA loop

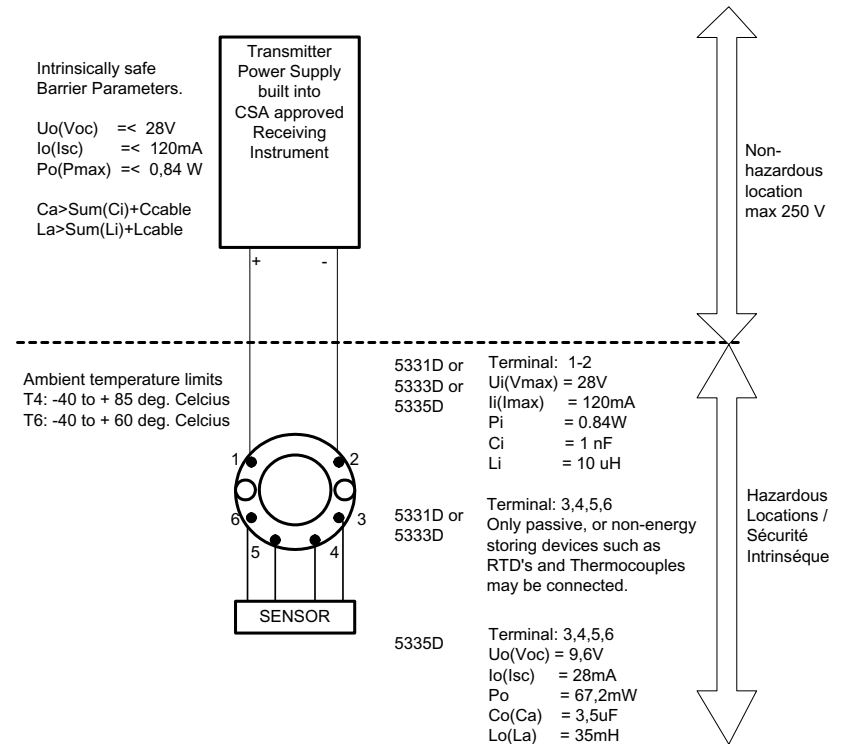

Warning:

Substitution of components may impair intrinsic safety.

The Transmitters must be installed in a suitable enclosure to meet installation codes stipulated in the Canadian Electrical Code (CEC).

DK ▶ PR electronics A/S tilbyder et bredt program af analoge og digitale signalbehandlingsmoduler til industriel automation. Vores kompetenceområder omfatter: Isolation, Displays, Ex-barrierer, Temperatur samt Backplanes. Alle produkter opfylder de strengeste internationale standarder, og størstedelen integrerer den patenterede STREAM-SHIELD teknologi, der sikrer driftssikkerhed i selv de værste omgivelser. Vores motto »Signals the Best« er indbegrebet af denne filosofi – og din garanti for kvalitet.

UK ▶ PR electronics A/S offers a wide range of analogue and digital signal conditioning modules for industrial automation. Our areas of competence include: Isolation, Displays, Ex barriers, Temperature, and Backplanes. All products comply with the most exacting international standards and the majority feature our patented STREAM-SHIELD technology ensuring reliability in even the worst of conditions. »Signals the Best« is the epitome of our philosophy – and your guarantee for quality.

FR ▶ PR electronics A/S offre une large gamme de produits pour le traitement des signaux analogiques et numériques dans tous les domaines industriels. Nos compétences s'étendent des transmetteurs de température aux afficheurs, des isolateurs aux barrières SI, jusqu'aux platines de montage. Tous nos produits sont conformes aux normes internationales les plus strictes et la majorité d'entre eux répondent même à la technologie brevetée STREAM-SHIELD qui garantit un fonctionnement fiable sous les conditions les plus défavorables. Notre devise »SIGNALS the BEST« c'est notre ligne de conduite - et pour vous l'assurance de la meilleure qualité.

DE ▶ PR electronics A/S verfügt über ein breites Produktprogramm an analogen und digitalen Signalverarbeitungsmodulen für die industrielle Automatisierung. Unsere Kompetenzbereiche umfassen: Displays, Temperaturtransmitter, Ex- und galvanische Signaltrenner. Alle Produkte von PR electronics werden in Übereinstimmung mit den strengsten internationalen Normen produziert. Für die Mehrzahl aller Produkte garantiert die patentierte STREAM-SHIELD Technologie höchste Zuverlässigkeit auch unter schwierigsten Einsatzbedingungen. »Signals the Best« ist Ihre Garantie für Qualität!

Subsidiaries

France
PR electronics Sarl
Zac du Chêne, Activillage
2, allée des Sorbiers
F-69500 Bron
sales@preelectronics.fr
tel. +33 (0) 4 72 14 06 07
fax +33 (0) 4 72 37 88 20

Germany
PR electronics GmbH
Bamlerstraße 92
D-45141 Essen
sales@preelectronics.de
tel. +49 (0) 201 860 6660
fax +49 (0) 201 860 6666

Italy
PR electronics S.r.l.
Via Giulietti, 8
IT-20132 Milano
sales@preelectronics.it
tel. +39 02 2630 6259
fax +39 02 2630 6283

Spain
PR electronics S.L.
Avda. Meridiana 354, 6°-A
E-08027 Barcelona
sales@preelectronics.es
tel. +34 93 311 01 67
fax +34 93 311 08 17

Sweden
PR electronics AB
August Barks gata 6
S-421 32 Västra Frölunda
sales@preelectronics.se
tel. +46 (0) 3149 9990
fax +46 (0) 3149 1590

UK
PR electronics Ltd
20 Aubery Crescent, Largs
Ayrshire, KA30 8PR
sales@preelectronics.co.uk
tel. +44 (0) 1475 689 588
fax +44 (0) 1475 689 468

USA
PR electronics Inc
16776 Bernardo Center Drive
Suite 203
San Diego, California 92128
sales@preelectronics.com
tel. +1 858 521 0167
fax +1 858 521 0945

Head office

Denmark
PR electronics A/S
Lerbakken 10
DK-8410 Rønne
www.preelectronics.com
sales@preelectronics.dk
tel. +45 86 37 26 77
fax +45 86 37 30 85



QUALITY SYSTEM AND ENVIRONMENTAL MANAGEMENT SYSTEM
DS/EN ISO 9001
DS/EN ISO 14001

